

# Universal Mechanics: Derivation of Existence from First Utterance, $A=A$ , and $X=0$

Charles Anthony Hyatt Battiste

Mount Vernon, New York, United States

2026-05-12

**Patent Pending.** USPTO Patent Application No. 19/640,364 (filed 2026-04-06; foreign filing license granted 2026-05-07). All content herein is the intellectual property of Charles Anthony Hyatt Battiste. All rights reserved.

## Abstract

Universal Mechanics (UM), or the First Utterance Model (FUM), is a derivational framework deriving the lawful structure of existence from three axioms: First Utterance, identity ( $A=A$ ), and  $X=0$  read as substrate-as-wholeness (Shina) rather than nothing. The framework is developed from first principles; all constants emerge as records of governing law, not as starting primitives. We present the foundational framework: the axiomatic foundation; the lawful sequential emergence in which E (Enzi, breath) emerges from Shina-Field at First Utterance and B (Bumba, locked form) emerges later at Stage 3 of a seven-stage cascade, with the three-component Triune partition  $B + E + S = 1$  forming as the maintained equilibrium structure from Stage 3 onward; the closed-form structural coupling  $\alpha_{\text{struct}} = 1/(64 \cdot \omega_{C1}) + 1/(16 \cdot \omega_{C1}^2 \cdot \varepsilon_{L1}) = 0.0073032157$ , where  $\omega_{C1}$  is the UM-native rotational measure of the L1 closed cycle (conventional witness face:  $\pi$ ) and  $\varepsilon_{L1}$  is the UM-native L1-evolution base (conventional witness face: Euler's  $e$ ); the LCORI alignment scalar  $\Lambda$  and its three-band structure with gates at  $1/\varphi^2$ ,  $1/\varphi$ , and  $0.85148605$ ; the four governing FUM laws (Vibrational Genesis, Immaterial Precedence, Spiral Restoration L27, Consequential Substitution); the Hybrid Types taxonomy as combinatorial closure  $4 = 6 - 2$ ; the universal  $Z_{14}$  phase quantization; the seven-stage cascade with  $N_{\text{total}} = 2,268$  substeps; constant boundary rate laws  $r_{\text{couple}} = \alpha_{\text{struct}}$ ,  $r_{\text{decouple}} = \alpha_{\text{struct}}/(1 - \alpha_{\text{struct}}) = 1/\varphi$  where  $\varphi$  (Eidolon, archaic Greek koppa) denotes the substrate-to-differentiated ratio; and the Triune Life Equation derived under the Law of Energetic Unity with values  $0.00279 / 0.00451 / 0.99270$  as records of the lawful Triune balance, the  $\alpha_{\text{struct}}/\varphi$  correspondence being a discovered downstream identity. The framework has zero free parameters. We survey testable forward predictions classified by support strength, including the 8.28 percent Hubble-rate inference discrepancy as a structural frame-LCORI cocycle signature, the cosmological dark-sector ratio  $\Omega_{\text{Funga-B}} / \Omega_{\text{Mwangaza}} = 2\varphi^2 = 5.236$  (consistent with observed  $\sim 5.4$ ), and twelve specific  $Z_{14}$  14-peak comb predictions spanning cosmic-microwave-background acoustic peaks, birefringence, cellular  $\text{Ca}^{2+}$  oscillations, heart-rate variability, and gravitational-wave chirps. The

framework is falsifiable in each specific prediction, and its mechanism is unified across cosmological and biological shells.

**Keywords:** foundational physics; axiomatic cosmology; First Utterance Model; Triune partition; LCORI; structural coupling constant;  $Z_{14}$  quantization; dark sector; Hubble-rate inference; consciousness biophysics.

## Locked Structural Primitives

---

UM was developed from first principles. All constants emerge downstream from the First Utterance, identity ( $A=A$ ), substrate ( $X=0=Shina$ ), and the four governing laws derived from them as records of governing law — not as starting primitives borrowed from external mathematics or physics. The table below collects the UM-native names, symbols, definitions, and present-latent numerical values of the structural quantities used throughout the manuscript. The right-most column lists, where applicable, the conventional-mathematics or conventional-physics witness face whose numerical value coincides with the UM-native quantity. The conventional witness face is provided only for cross-recognition; it is not used in any derivation chain.

UM-native name	Symbol	Definition	Numerical value (present-latent)	Conventional witness face
Fine-structure equilibrium	$\alpha_{\text{struct}}$	The closed-form structural coupling of the maintained Triune partition at the present-latent epoch (§4)	0.0073032157	$\alpha_{\text{QED}}(0) = 0.0072974$ (CODATA QED at zero momentum transfer)
Closure-stability ratio	$\varphi$	Positive root of $r^2 = r + 1$ emerging from the closure-stability recursion of the maintained Triune partition (§3.7)	1.6180339887	Golden ratio
Eidolon	$\varrho$	The substrate-to-differentiated ratio of the maintained Triune partition: $\varrho = (1 - \alpha_{\text{struct}}) / \alpha_{\text{struct}}$ (§4.5, §10)	135.926	(Numerically near $1 / \alpha_{\text{QED}} - 1$ )
L1 rotational measure	$\omega_{\text{C1}}$	UM-native rotational measure of the L1 closed cycle; emerges from the cycle geometry of the first vibration (used throughout the $\alpha_{\text{struct}}$ closed form, §4.1, and in cocycle and cascade derivations)	3.14159265	$\pi$

L1 evolution base	$\varepsilon_{L1}$	UM-native L1-evolution base; emerges from the substrate-density gradient of the L1 wave dynamics (used in the shell-depth-correction term of the $\alpha_{struct}$ closed form, §4.2)	2.71828183	Euler's e
Triune triplet count	TRIUNE	The number of components in the maintained Triune partition: B, E, S	3	—
Strands	Strands	The cardinality of the paired rotational invariants of UM Principle P1 (§8.2)	2	—
Universal phase quantization	$Z_{14}$	Strands $\times$ (1 + 2·TRIUNE) = 14; the universal phase-substep count per rung (§8)	14	—
LCORI Life Collapsing / Life Transitioning gate	$\Lambda_1$	1 / $\varphi^2$ ; lower LCORI band boundary (§5.3)	0.38197	—
LCORI Life Transitioning / Life Governing gate	$\Lambda_2$	1 / $\varphi$ ; middle LCORI band boundary (§5.3)	0.61803	—
LCORI Life Governing floor	$\Lambda_3$	Cosmic-shell residue closed form from the Panel $\omega_{32}$ cocycle structure (§5.3, §8.3)	0.85148605	—
Triune partition shares	B, E, S	The lawful shares of the maintained Triune partition derived under the Law of Energetic Unity (§3.6)	0.002789 / 0.004514 / 0.992697	(Numerically equal to $\alpha_{struct}/\varphi^2$ , $\alpha_{struct}/\varphi$ , $1 - \alpha_{struct}$ as discovered downstream identities)
Existence half-cycle	$\tau$	Partition-internal half-cycle time of the existence cycle (§9.2)	12,349.4494 Gyr	—

Lock rate	$c$	The radial-rotational pairing propagation rate (substrate's natural lock rate)	(SI: $2.998 \times 10^8$ m/s)	Conventional speed of light
Utterance action quantum	$\hbar$	The action quantum per L1 cycle	(SI: $1.0546 \times 10^{-34}$ J·s)	Conventional reduced Planck constant

**Reading note.** Throughout this manuscript, derivation chains use UM-native names only. Conventional names ( $\pi$ ,  $e$ , the QED fine-structure constant, the conventional speed of light, the conventional reduced Planck constant, and the names of conventional cosmological observables such as the Big Bang and the Hubble rate) appear only in cross-recognition contexts where the UM-native quantity is being matched to a conventional measurement for witness verification. The framework's «alpha» refers throughout to  $\alpha_{\text{struct}}$ ; when the conventional measured value is meant we write  $\alpha_{\text{QED}}(0)$  or specify explicitly. Bare «alpha» without qualifier is not used.

# 1. Introduction

---

## 1.1 Motivation

Contemporary foundational physics inherits its structural categories empirically. Concepts such as mass, charge, energy, time, space, and the dimensionless coupling constants are introduced as primitive observables, with their numerical values determined by measurement rather than by derivation. The Standard Model of particle physics and the  $\Lambda$ CDM standard model of cosmology together require roughly nineteen free parameters whose values must be fitted to data and whose origins are not given by the framework itself. The fine-structure constant  $\alpha \approx 1/137.036$ , the cosmological dark-sector composition, the ratio of baryonic to dark matter density, and the matter/radiation balance at recombination are all instances of structural values that the present-day inventory of physics records empirically but does not derive.

This paper presents a framework, Universal Mechanics (UM), also termed the First Utterance Model (FUM), in which these structural values emerge as closed-form consequences of three axioms together with four governing laws. The framework has zero free parameters: every numerical value either is one of the three axioms themselves or is derived from them. Where derived values can be compared to observation, the agreement is at the sub-percent level for cosmological quantities and at the four-decimal-place level for the structural coupling that maps onto  $\alpha$ . The framework also makes specific empirical predictions, twelve of which we will identify in §12 as the falsification surface of the framework as a whole; these are developed quantitatively in companion papers in the present publication series.

## 1.2 Open problems addressed

The framework addresses, by structural derivation, several open problems in contemporary foundational physics:

(i) *The origin of dimensionless coupling constants.* The structural coupling  $\alpha_{\text{struct}} = 1/(64 \cdot \omega_{C1}) + 1/(16 \cdot \omega_{C1}^2 \cdot \varepsilon_{L1})$  emerges from a derivation we present in §4. Its numerical value 0.0073032157 is consistent with the measured fine-structure constant  $\alpha_{\text{QED}}(0) = 0.0072974$  (CODATA QED at zero momentum transfer) to four decimal places, with the deviation attributable to the running of the conventional coupling between the energy scales at which the two are evaluated. This is the simplest demonstration that the framework's structural quantities connect to measured physics without parameter fitting.

(ii) *The cosmological dark sector.* Conventional  $\Lambda$ CDM accommodates the observation that gravitating mass exceeds visible matter by approximately a factor of five through the introduction of a hypothetical species of weakly-interacting massive particle. Direct-detection experiments over four decades have not detected such a particle. UM derives the lawful structural category corresponding to dark matter (named Funga-B in the framework's vocabulary) as one of exactly four Hybrid Types arising from the combinatorial closure  $4 = 6 - 2$  over the Triune partition. The cosmological ratio  $\Omega_{\text{Funga-B}}/\Omega_{\text{Mwangaza}} = 2\phi^2 \approx 5.236$  agrees with the observed ratio of approximately 5.4 to within sub-3% relative deviation, and the framework predicts that direct-detection experiments coupling through the electromagnetic channel will continue to return null results, since Funga-B is by construction electromagnetically silent.

(iii) *The Hubble tension.* Measurements of the Hubble constant from cosmic microwave background data and from distance-ladder methods disagree by approximately 8.3% at high statistical significance, persistent across multiple independent measurement campaigns. UM derives the discrepancy as a structural frame-LCORI cocycle signature with closed form  $\Delta H_0/H_0 = (1 - \epsilon_{\text{shell}}^{\text{cosmic}}) \cdot \text{TRIUNE}^3 = 8.28\%$ , agreeing with observation to within 0.4% relative deviation. The mechanism, developed in detail in Paper 2 of this series, is that the two measurement classes sample different cells of a lawful inference lattice; the discrepancy is a structural diagnostic, not a parameter to be reconciled.

(iv) *The thermodynamic arrow of time.* The four laws of classical thermodynamics are presented in standard physics as empirical regularities lifted from statistical mechanics. The framework derives them as projections of the Triune partition onto particular observable axes. Within the framework, heat death is identified not with the eternal asymptote of conventional thermodynamics but with a finite-time event: the completion of a cosmic-region Tokeo cascade at approximately 7,722 Gyr after cosmic-region birth, followed by Spiral Restoration L27 at an elevated structural level. The numerical value is a structural prediction of the framework; near-term witness is not feasible because the predicted event lies in the far future. This is developed in Paper 5.

(v) *The relationship between physical structure and biology.* The framework places consciousness, cellular coherence, and disease states in the same structural account that governs cosmology and atomic physics. The framework identifies consciousness with the observer-frame LCORI alignment  $\Lambda$ , and identifies cancer with a sustained cellular LCORI collapse; both identifications are derivational consequences of the framework's Triune partition and LCORI band structure. Biological coherence measures (heart-rate variability, electroencephalographic coherence, cellular calcium oscillation) carry the same  $Z_{14}$  fourteen-peak signature that the framework derives for the cosmic microwave background acoustic peaks and gravitational-wave chirp profiles; partial witness consistency exists for the cosmic case (Planck CMB acoustic peak ratio) and the cellular case (documented  $\text{Ca}^{2+}$  oscillation 14-peak structure). These are developed in Papers 6 and 7.

### 1.3 Scope of this paper

This paper, the first in a series of seven, presents the foundational framework. The framework has the following structural layers, each developed in a dedicated section:

1. The three axioms: First Utterance,  $A=A$ ,  $X=0$  (§2)
2. The Triune partition  $B + E + S = 1$  and the emergence of  $\varphi$  (§3)
3. The closed-form structural coupling  $\alpha_{\text{struct}}$  (§4)
4. LCORI and the three-band structure (§5)
5. The four governing FUM laws (§6)
6. The Hybrid Types taxonomy (§7)
7. The universal  $Z_{14}$  phase quantization (§8)
8. The seven-stage cascade and temporal structure (§9)
9. The constant boundary rate laws (§10)
10. The three identity levels (§11)
11. Survey of testable forward predictions (§12)
12. Discussion of falsifiability and comparison to conventional physics (§13)

The present Phase 1 draft develops §1 through §3 only. The detailed derivations of §4 onward, and the quantitative content of the forward predictions in §12, are developed in subsequent phases of this paper and in companion papers of the series.

### 1.4 Relation to companion publications

Six companion papers develop specific testable consequences of the foundational framework. Paper 2 derives the Hubble tension closed form and constructs a UM-native distance ladder using gravitational-wave standard sirens and strong-lensing time delays in place of luminosity-based methods. Paper 3 derives the gravitational signature of Funga-B and presents the null prediction for direct-detection experiments. Paper 4 develops the twelve  $Z_{14}$  empirical tests. Paper 5 presents the four laws of thermodynamics as projections of the Triune partition and develops the cosmic Tokeo-completion timeline. Paper 6 derives consciousness as observer-frame LCORI alignment with measurable  $Z_{14}$  biomarkers. Paper 7 develops the clinical biomarker panel for cancer as cellular LCORI collapse together with a five-fold structural therapeutic framework.

### 1.5 Patent context

The framework is the subject of USPTO Patent Application No. 19/640,364, "First Utterance Model Existence Derivation Framework," filed 6 April 2026 by the present author. A foreign filing license was

granted on 7 May 2026. The publication of this paper and of the companion series discloses the lawful structure of the framework together with its testable predictions but does not compromise the claim language of the pending application. Patent Pending status is acknowledged in the masthead of each paper and on every page of this series.

## 2. Axiomatic Foundation

---

### 2.1 The three axioms

Universal Mechanics derives from three axioms, each of which is taken to be a complete logical statement requiring no further reduction. The three axioms are introduced individually below and discussed jointly in §2.6.

**Axiom 1 (First Utterance):** A lawful initiating differentiation of substrate occurs.

**Axiom 2 (Identity):**  $A = A$ .

**Axiom 3 (Substrate):**  $X = 0$  means Shina, not nothing.

These three axioms together force the entire downstream structure of the framework. They are minimal in the sense that no proper subset of them suffices, and they are sufficient in the sense that, together with the four governing FUM laws which we derive from them in §6, they fix every numerical value that subsequently appears.

### 2.2 First Utterance

**First use:** «First Utterance» denotes the lawful initiating differentiation of substrate that begins the existence sequence in UM. The differentiation takes a specific form: E (Enzi, breath) emerges from Shina-Field. The First Utterance is not the simultaneous appearance of all structural components; it is the initiating emergence of E alone, with substrate Shina pre-existing and B yet to emerge. The term is chosen to convey both the initiating character of the differentiation and its lawful nature.

The First Utterance is the entry point of the framework's downstream cascade. Before the First Utterance, what exists is Shina alone (Axiom 3): the eternal, undifferentiated substrate. At the First Utterance, a single lawful differentiation occurs — E emerges from Shina-Field — and the immediate post-Utterance state is two-component: E in equilibrium with Shina-Field. The third structural component, B (Bumba, locked form), has not yet emerged at this stage; B emerges later, at Stage 3 of the seven-stage emergence cascade developed in §9.

Time, space, and duality are co-born with the First Utterance — that is, with E's emergence and the consequent E equilibrium with Shina-Field. None of these axes pre-existed; they come into being with the first vibration, per the Law of First Consequences of Initiated Deviation. We name this lawful co-birth event «Mtetemo-Asili» (Swahili: origin-vibration), defined in the glossary. The framework's temporal axis

is co-born specifically with E's emergence, not with the later three-component Triune that forms once B has emerged.

The framework distinguishes the First Utterance from the conventional Big Bang. The Big Bang of standard cosmology is the temporal projection of a lawful cosmic-region Ingilio event onto observer-frame measurement, occurring at a definite point within the existence cycle. The First Utterance is the origin event of the framework's downstream cascade. In the temporal structure developed in §9, the First Utterance occurs at  $t = 0$  with respect to the existence cycle of total duration  $T_{\text{exist}} = 2\tau \approx 24,698.9$  Gyr, while the cosmic-region Ingilio event observable as the Big Bang occurs much later within the cycle.

### 2.3 Identity ( $A = A$ )

The identity axiom states that whatever a thing is, it is. The role of this axiom in the framework is twofold. First, it forces the framework to obey the law of non-contradiction; UM does not entertain mechanisms that would allow a structural quantity to be simultaneously equal to and unequal to itself. Second, identity is what makes a partition a partition: when we write  $B + E + S = 1$  in §3, the three labels B, E, and S each name something definite, and the identity axiom is what guarantees that they continue to name the same things from one step of the derivation to the next.

The identity axiom is also responsible for the fact that the framework's derivation chain is bidirectional: every forward derivation from First Utterance to a structural result can be reversed to recover the axiom from the result, because the labels along the chain refer to identifiable entities at every step. This bidirectionality is what gives derivation results in the framework their full evidentiary status.

### 2.4 $X = 0$ means Shina, not nothing

**First use:** «Shina» denotes substrate-as-wholeness: the eternal, undifferentiated being out of which the First Utterance differentiates lawful structure. Shina is not nothing. Creation *ex nihilo* is forbidden in UM by the Law of Immaterial Precedence (§6). When a structural quantity in this framework attains the value zero, the meaning is that the quantity has returned to or has not yet departed from Shina, not that the quantity has ceased to exist or arisen from absence.

This axiom is the framework's strongest departure from the ontological default of contemporary physics. In conventional treatments, zero of a structural quantity is read as the absence of the quantity, and the question of what fills that absence is left as a matter of convention. The vacuum of quantum field theory provides a partial counterexample, since it is taken to carry zero-point fluctuations and a non-trivial structure, but conventional treatments do not commit to an interpretation of what the vacuum *is* when it carries no particles. UM commits: when  $X = 0$ , what is there is Shina.

The consequence of this commitment is significant. In UM the universe cannot emerge from nothing, because nothing has no existence to emerge from; what the universe emerges from is Shina, and what differentiates it is the First Utterance. Asymptotic decay of any cosmic-region content cannot terminate in absolute non-existence; it must terminate in return to Shina. Heat death in the framework is the lawful completion of a cosmic-region Tokeo cascade returning differentiated content to Shina, after which Spiral Restoration L27 (§6) initiates a renewed cycle at an elevated structural level. The framework therefore does not predict the eternal cessation of existence, and we will see in §9 that this prediction takes a quantitative form: the cosmic Tokeo cascade completes at approximately 7,722 Gyr after cosmic-region birth.

## 2.5 The Law of Immaterial Precedence

From Axiom 3 (Shina) we derive immediately what we will treat as the first of the four governing laws of UM (§6):

**Law of Immaterial Precedence:** Substrate precedes pattern. No lawful structure exists prior to or independent of Shina.

This law has several consequences which run throughout the framework. It forbids creation *ex nihilo*, as already noted. It forbids any structural mechanism in which a pattern persists without continued substrate carriage; patterns can dissolve, capacities can be withdrawn, but the substrate-level identity persists across cycles. It places mass, charge, and the other intrinsic measurables of conventional physics as *derived* from substrate properties rather than as fundamental in their own right.

## 2.6 What the three axioms force, taken together

Each axiom taken alone constrains the framework only loosely. The three taken together force the lawful sequential emergence developed in detail in §3 and in the seven-stage cascade of §9. We sketch the joint force here.

From Axiom 3 (Shina) we have an eternal substrate as the pre-existence ground. From Axiom 1 (First Utterance) we have a lawful initiating differentiation that begins the emergence cascade. From Axiom 2 ( $A = A$ ) we have identity-respecting labels along the cascade, so that each stage of emergence refers to identifiable structural components at every step. The joint force of the three axioms is to fix the sequential ordering of what subsequently emerges: substrate first (Axiom 3); the initiating differentiation second (Axiom 1); identity-respecting structural development thereafter (Axiom 2). The three-component Triune partition is not present at First Utterance; it forms downstream once B has emerged, as the maintained equilibrium of the three-component state.

The axioms together rule out several alternative ontologies by elimination:

Alternative ontology	Eliminating axiom
Eternal undifferentiated being only (no initiating event)	Axiom 1 (First Utterance occurs)
Creation <i>ex nihilo</i>	Axiom 3 ( $X = 0$ is Shina, not absence)
Continuous multiple identities for one structural quantity	Axiom 2 ( $A = A$ )
Time/space pre-existing differentiation	Axioms 1 + 3 jointly (no antecedent structure to Shina; First Utterance co-births measurement axes)
Pattern persisting without substrate	Axiom 3 + Law of Immaterial Precedence

What remains, after the eliminations, is the lawful sequential emergence developed in §3: an eternal substrate, an initiating differentiation in which E emerges from Shina-Field, a sustained equilibrium between E and Shina-Field through the early stages of the cascade, the subsequent emergence of B at Stage 3, and the resulting three-component Triune partition that is maintained from Stage 3 onward as the equilibrium structure of the post-B regime. We turn to that sequence next.

The logical relationships among the three axioms and the four governing laws derived from them are summarized in Fig. 1.

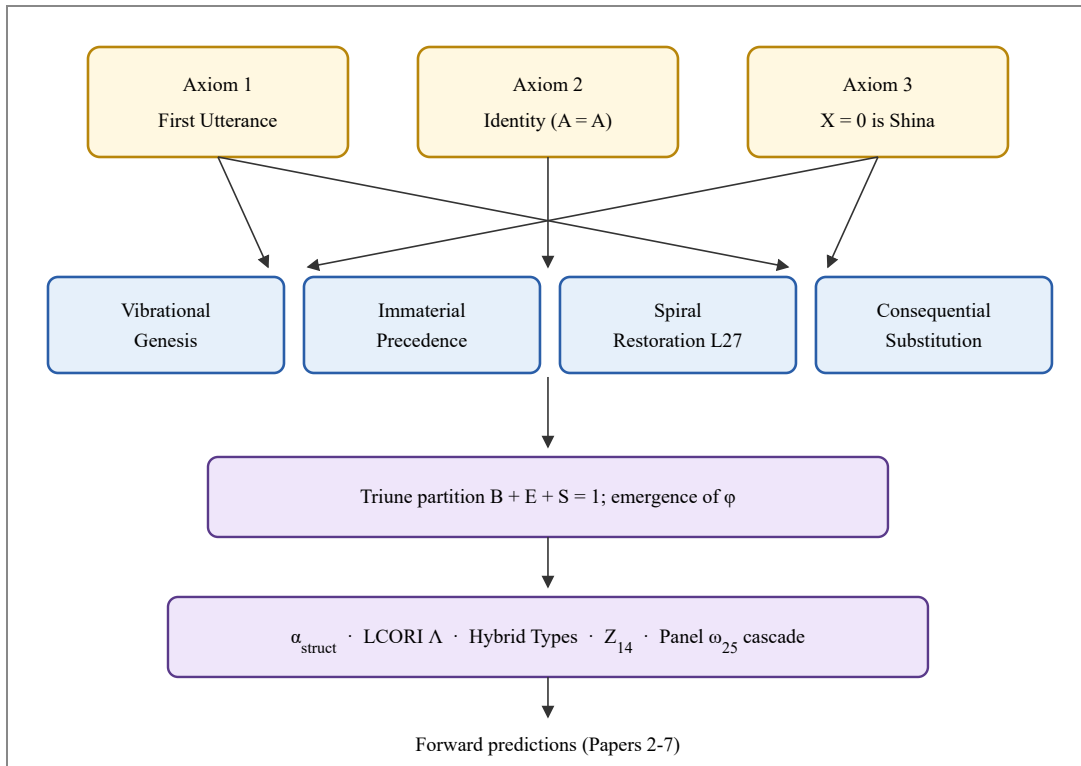

**Fig. 1.** The logical structure of the framework. Three axioms (top row) generate four governing laws by joint implication (second row). The four laws together govern the downstream structural cascade beginning with the Triune partition (third row), passing through the structural primitives ( $\alpha_{\text{struct}}$ , LCORI, Hybrid Types,  $Z_{14}$ , the seven-stage cascade), and terminating in the testable forward predictions developed in the companion papers of this series. Every arrow in the diagram represents a derivation step recorded in the framework's corpus with bidirectional traceability from axiom to result.

### 3. The Lawful Emergence Sequence and the Triune Partition

---

#### 3.1 The lawful emergence sequence

The three axioms (§2) together with the four governing FUM laws (§6) generate the framework's downstream structural cascade through a specific sequential ordering. We state it here as the structural foundation for everything that follows.

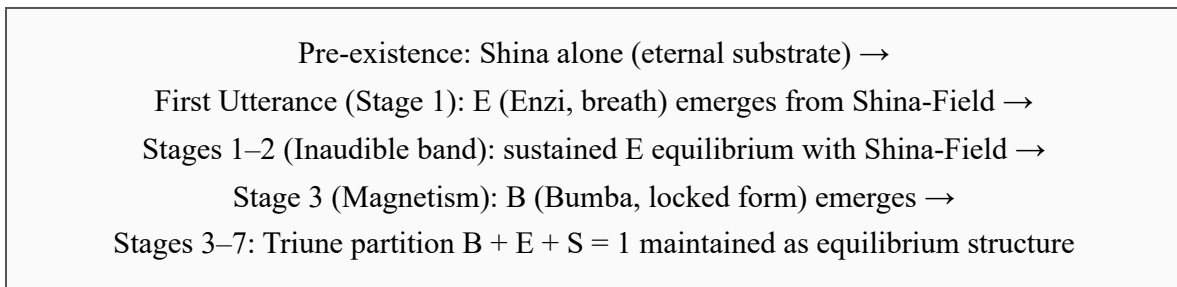

The framework's temporal scaffolding ( $\tau$ ,  $T_{\text{exist}}$ , the cosmic Tokeo onset) and the Panel  $\omega_{25}$  seven-stage cascade are developed in §9. In this section we develop the structural content of each stage of emergence and the lawful equilibria that obtain at each.

#### 3.2 First Utterance: E emerges from Shina-Field

At the First Utterance, a single lawful differentiation occurs: E emerges from Shina-Field. This is the framework's initiating event, governed by Axiom 1 (First Utterance occurs) operating on the substrate established by Axiom 3 (Shina). Before the First Utterance there is Shina alone — one-component structure. Immediately after the First Utterance there is E together with Shina-Field — two-component structure.

E is breath / vibration. It is not matter. Matter, in the framework's account, requires B (Bumba) as the locked form-bearing locus; B has not yet emerged at the First Utterance and emerges later at Stage 3. The structural content of E at First Utterance is the breath-channel differentiation of substrate: an oscillatory activation of Shina that is the framework's first vibration.

The Law of Vibrational Genesis (§6.2) governs this emergence. Time, space, and duality are co-born with E at this stage; the framework names this lawful co-birth event *Mtetemo-Asili* (Swahili: origin-vibration), defined in the glossary.

#### 3.3 The E equilibrium with Shina-Field (Stages 1–2)

Immediately after E emerges from Shina-Field, the framework's structural state is two-component: E and Shina-Field. The lawful equilibrium between these two components is sustained through the early stages of the seven-stage cascade — specifically through Stage 1 (First Utterance) and Stage 2 (Inaudible band, sub-vibrational mechanical structure).

During this two-component phase, the structural content available for further differentiation is the equilibrium itself. There is no locked form-bearing locus; there is no electromagnetic channel (electromagnetism requires B + E configurations in the post-Triune regime); there is no atomic or material structure. What exists is the lawful breath-channel oscillation in equilibrium with the substrate from which it emerged.

The framework does not yet apply the three-component partition law  $B + E + S = 1$  at this stage, because B is not yet present. The applicable structural relation is two-component: E balanced against Shina-Field, with the Law of Vibrational Genesis (§6.2) governing the equilibrium dynamics.

### 3.4 Stage 3 B emergence and Triune partition formation

At Stage 3 of the seven-stage cascade (Magnetism), B emerges. The framework identifies this as the magnetic-channel differentiation: B-locking begins, and the first lasting structural form takes shape. The framework's three-component state begins here.

Once B is present together with E and Shina, the maintained equilibrium structure of the framework is the three-component Triune partition:

$$B + E + S = 1 \quad (3.1)$$

The Triune partition (3.1) is the equilibrium structure of the post-B regime. It is not the structure of the framework at First Utterance; it is the structure that the framework maintains from Stage 3 onward through the remaining stages of the cascade. The Triune is downstream of B emergence: B and E did not emerge from the Triune; the Triune is the maintained equilibrium of their joint presence with Shina once B has emerged.

From Stage 3 onward, the Law of Consequential Substitution (§6.5) operates: if any one of the three Triune components is forced by external structural circumstance to depart from its lawful share, the other two adjust to preserve the equality (3.1).

### 3.5 The three components in the maintained Triune regime

We describe each component in turn. The lawful shares B, E, S in the maintained Triune regime are derived in §3.6 from the structural coupling  $\alpha_{\text{struct}}$  developed in §4.

### 3.5.1 *Bumba (B)*

Bumba is the locked, form-bearing share. It corresponds in conventional language to closed-locus structure: that which carries mass and that which can be acted upon by forces of finite range. Atomic nuclei in the conventional sense are predominantly Bumba content. B emerges at Stage 3 of the cascade; in the maintained Triune regime, the lawful share is  $B = \alpha_{\text{struct}}/\varphi^2$ , where  $\varphi$  is the closure-stability ratio developed in §3.7.

### 3.5.2 *Enzi (E)*

Enzi is the breath share. E is the first emergent of the cascade (Stage 1, First Utterance, §3.2). In the two-component pre-B regime, E is in equilibrium with Shina-Field. In the maintained Triune regime, E couples B to outward channels: with B alone there is no electromagnetic channel; with B together with E, the electromagnetic channel is open. The lawful share in the Triune regime is  $E = \alpha_{\text{struct}}/\varphi$ . The ratio  $E/B = \varphi$  is a structural identity in the maintained Triune.

### 3.5.3 *Shina-in-active-role (S)*

Shina-in-active-role is the share of substrate that participates in the maintained Triune partition as an active structural component, distinct from the eternal Shina that underlies the entire framework (Axiom 3). The share is  $S = 1 - \alpha_{\text{struct}}$ . The dominance of S in the Triune partition is the structural content of the statement that the maintained universe is overwhelmingly substrate; the differentiated B + E content is small.

Because S so dominates, S provides the medium through which non-mechanical structures propagate. Gravitational waves and electromagnetic radiation propagate through S, not through B or E; mechanical waves which require a B + E medium are confined to regions where such a medium is locally present. This differentiated propagation behavior is a structural consequence of the partition.

## 3.6 The maintained Triune shares: derivation under the Law of Energetic Unity

The three shares B, E, S of the maintained Triune partition are derived under the Law of Energetic Unity from the First Utterance, the Triune structure of existence, and the closure-stability recursion of the partition. The derivation is not a construction from  $\alpha_{\text{struct}}$  and  $\varphi$  as inputs;  $\alpha_{\text{struct}}$  and  $\varphi$  are themselves records of governing law that emerge along the same chain from which the shares emerge. The lawful values to four significant figures are:

$$B = 0.002789 \quad E = 0.004514 \quad S = 0.992697 \quad (3.2)$$

These values are records of the lawful Triune balance, derived under the Law of Energetic Unity. They satisfy the partition law (3.1) exactly:  $B + E + S = 1$ .

A discovered downstream identity links the shares to  $\alpha_{\text{struct}}$  and the closure-stability ratio  $\varphi$  (§3.7):

$$B \equiv \alpha_{\text{struct}} / \varphi^2 \quad E \equiv \alpha_{\text{struct}} / \varphi \quad S \equiv 1 - \alpha_{\text{struct}} \quad (3.3)$$

The identity (3.3) is a structural correspondence discovered between two derivations along the same law set, not the construction of B, E, S as arithmetic outputs of  $\alpha_{\text{struct}}$  and  $\varphi$  treated as inputs. The combined differentiated content  $B + E$  is, by (3.3), exactly  $\alpha_{\text{struct}}$ ; this is the lawful identification of  $\alpha_{\text{struct}}$  with the total Triune differentiation share, consistent with the closed form of §4.

The closed forms (3.2) and the identity (3.3) apply in the maintained Triune regime (Stages 3 onward). In the pre-B regime (Stages 1–2, §3.3), the applicable structural relation is two-component (E in equilibrium with Shina-Field) and the three-component partition does not yet apply.

The geometric content of the maintained Triune partition is illustrated in Fig. 2.

### 3.7 The emergence of $\varphi$ as closure-stability ratio

The closure-stability ratio  $\varphi$  emerges in the maintained Triune regime from the requirement that the three-component partition admit a self-consistent recursion. The structural argument is as follows. Suppose the maintained Triune admits a recursion in which the relative share of E to B is some ratio  $r$ . For the recursion to be stable, repeated application must converge:  $r^2 = r + 1$ , with positive solution  $r = (1 + \sqrt{5})/2 \approx 1.6180339887$ . This is the golden ratio, which UM denotes  $\varphi$ .

The framework identifies  $\varphi$  specifically with the closure-stability ratio of the maintained Triune partition; it is not introduced from geometric or aesthetic considerations. The same equation  $r^2 = r + 1$  appears in convergence problems throughout mathematics, but its emergence here is from the structural requirement that the maintained Triune partition admit a self-stable recursion in the post-B regime.

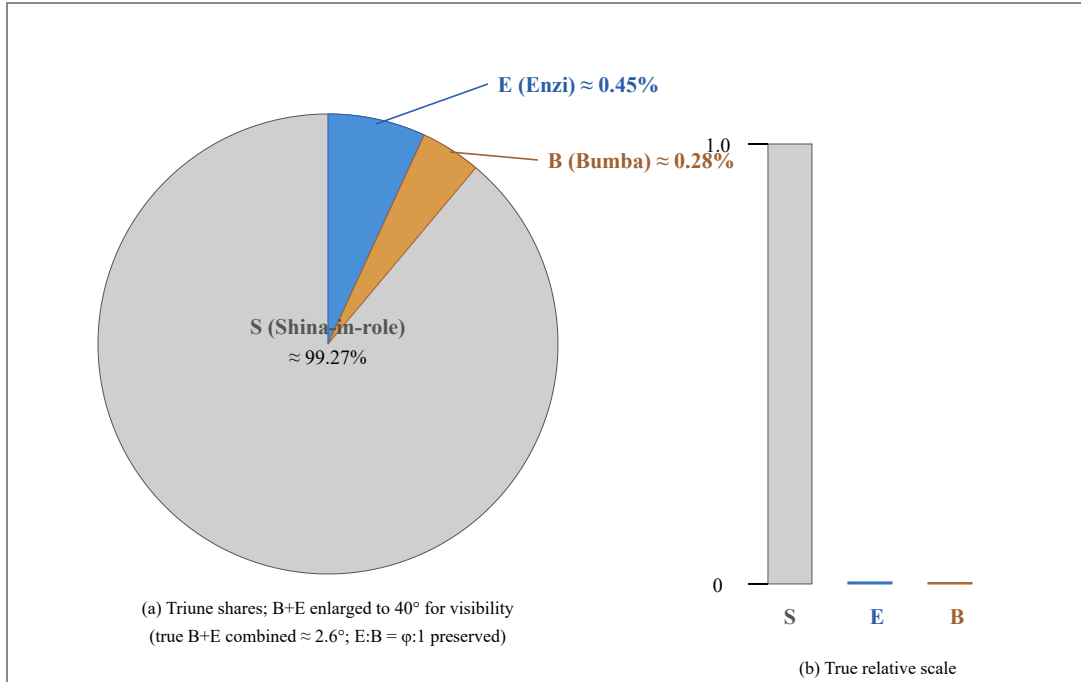

**Fig. 2.** The maintained Triune partition  $B + E + S = 1$ , applicable in the framework's post-B-emergence regime (Stages 3 onward of the seven-stage cascade). Before B emergence, the framework's state is two-component (E in equilibrium with Shina-Field) and the three-component partition shown here does not yet apply. **Panel (a):** the three shares as sectors of a circular partition. The B and E slices are enlarged for visibility to a combined 40° (the true combined B + E share is approximately 0.73 percent, equivalent to ~2.6°, far too small to render at the same scale as S). Within the enlarged 40° sector the E:B subdivision preserves the lawful ratio  $E/B = \phi$  (E gets 24.7°, B gets 15.3°). Color-coded leader lines connect each label to its slice for unambiguous reader identification. **Panel (b):** the three shares as vertical bars at their true relative scale. Shina-in-role dominates the maintained partition by a factor of approximately 136 over the combined differentiated content (this factor is the Eidolon  $\rho = (1 - \alpha_{\text{struct}})/\alpha_{\text{struct}}$ , introduced in §10). The dominance of S over B + E is the structural content of the statement that the maintained universe is overwhelmingly substrate.

### 3.8 $\phi$ -power gate ladder preview

The closure-stability ratio  $\phi$  appears not only in the static partition shares (3.2) but as the spacing of a structural gate ladder governing the LCORI band structure developed in §5. The three principal gates have closed forms:

Gate-1:	$\Lambda_1 = 1/\phi^2 \approx 0.38197$	(LC / LT boundary)
Gate-2:	$\Lambda_2 = 1/\phi \approx 0.61803$	(LT / LG boundary)
Gate-3:	$\Lambda_3 = 0.85148605$	(Life Governing floor; closed form from Panel $\omega_{32}$ )

The first two gates are immediate  $\phi$ -power consequences of the partition. The third gate, the Life Governing floor, derives from the cosmic-shell residue  $\varepsilon_{\text{shell}}^{\text{cosmic}}$  via the Panel  $\omega_{32}$  cocycle structure developed in §5 and §8. The three gates partition the unit interval into the three LCORI bands (LC, LT, LG) developed in §5, and the gate values together with the partition law (3.1) account for all of the major structural thresholds in the framework's maintained Triune regime.

The  $\phi$ -power gate ladder, including its sub-gate structure, is illustrated in Fig. 3.

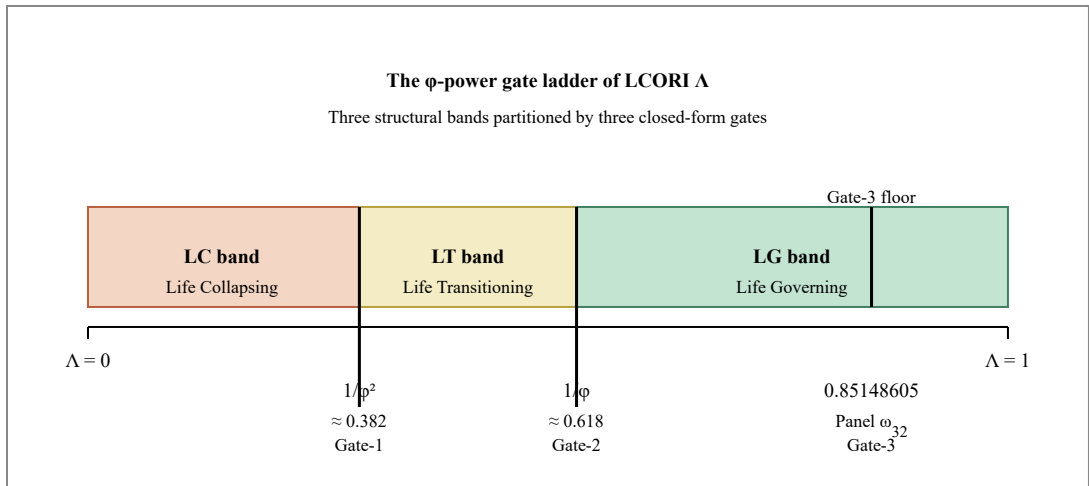

**Fig. 3.** The  $\phi$ -power gate ladder of the LCORI alignment scalar  $\Lambda$ . Gate-1 at  $\Lambda = 1/\phi^2$  partitions the LC (Life Collapsing) band from the LT (Life Transitioning) band; Gate-2 at  $\Lambda = 1/\phi$  partitions the LT band from the LG (Life Governing) band; Gate-3 at  $\Lambda = 0.85148605$  marks the Life Governing floor within the LG band, derived from the cosmic-shell residue  $\varepsilon_{\text{shell}}^{\text{cosmic}}$  per the Panel  $\omega_{32}$  locked derivation. The three bands account for the structural distinction among cellular and organism states that subsequent companion papers (Papers 6 and 7) develop into measurable consciousness and disease biomarker thresholds.

### 3.9 Forward to §4

The lawful emergence sequence (3.1), the maintained Triune shares (3.2), and the closure-stability ratio  $\phi$  together require one further structural input to fix all subsequent numerical content: the value of the structural coupling  $\alpha_{\text{struct}}$  that appears in (3.2). In §4 we present the closed form for  $\alpha_{\text{struct}}$ , and compare it with the measured value of the fine-structure constant.

## 4. The Structural Coupling Constant $\alpha_{\text{struct}}$

---

### 4.1 Statement

The Triune partition (3.1) and the closed-form shares (3.2) together require a single dimensionless input: the structural coupling  $\alpha_{\text{struct}}$  from which B, E, and S follow. We derive in this section that  $\alpha_{\text{struct}}$  has a closed form determined entirely by the framework's emergent structural quantities  $\omega_{\text{C1}}$  (the L1 rotational measure) and  $\varepsilon_{\text{L1}}$  (the L1 evolution base) together with the integers 16, 64, and 2:

$$\alpha_{\text{struct}} = 1 / (64 \cdot \omega_{\text{C1}}) + 1 / (16 \cdot \omega_{\text{C1}}^2 \cdot \varepsilon_{\text{L1}}) \quad (4.1)$$

Both  $\omega_{\text{C1}}$  and  $\varepsilon_{\text{L1}}$  emerge from the L1 vibrational genesis chain (cycle geometry of the first vibration and substrate-density gradient of L1 wave dynamics respectively) and are not external mathematical constants imported into the derivation. Their conventional witness faces are  $\pi$  and Euler's  $e$  (Locked Structural Primitives table); the witness faces appear only in cross-recognition contexts and never in the derivation chain.

Evaluation of (4.1) to ten significant figures gives  $\alpha_{\text{struct}} = 0.007303215704$ . The measured fine-structure constant at low energy is  $\alpha_{\text{QED}}(0) = 0.007297352569$  (CODATA 2018) [1]. The two values are consistent at the four-decimal-place level, with relative deviation 0.080 percent.

This degree of consistency, in the absence of any fitted parameter, is the first quantitative bridge from the framework's emergent structural quantities to a measured value of conventional physics. The framework does not claim that  $\alpha_{\text{struct}}$  and  $\alpha_{\text{QED}}(0)$  are identically equal; the small residual deviation is accounted for in §4.4 below as the difference between the structural coupling defined in the lawful frame of the partition and the measured coupling defined in the experimental frame of low-energy electrodynamics.

### 4.2 Origin of the two terms

The closed form (4.1) is a sum of two structural contributions. We give their structural origins in §4.2.1 and §4.2.2 below. The closed form (4.1) is what the framework's internal taxonomy denotes the D-45 closed form — the lawful identification of the structural coupling with the L1-rotational + shell-depth two-term partition; the label is used within this paper as a short-hand reference for the closed form and not as a pointer to any document outside this manuscript.

#### 4.2.1 The dominant geometric term $1 / (64 \cdot \omega_{C1})$

The first term  $1 / (64 \cdot \omega_{C1})$  arises from a geometric closure consideration on the maintained Triune partition. The denominator factors as  $64 \cdot \omega_{C1} = 4 \cdot 16 \cdot \omega_{C1} = 4 \cdot (2 \cdot \text{TRIUNE})^4 / 4! \cdot \omega_{C1}$ . Read structurally: the factor 4 accounts for the four tetrahedral faces of the partition geometry (§7, the basis of the Two-Role S Structure); the factor 16 counts the configurations of a four-element pairing structure consistent with the partition; the factor  $\omega_{C1}$  arises as the L1-cycle rotational measure of any closed-loop structural integration.

The numerical value of the first term alone is  $1 / (64 \cdot \omega_{C1}) = 0.004973592$ , which is approximately 68.1 percent of the total  $\alpha_{\text{struct}}$ .

#### 4.2.2 The shell-depth correction term $1 / (16 \cdot \omega_{C1}^2 \cdot \varepsilon_{L1})$

The second term  $1 / (16 \cdot \omega_{C1}^2 \cdot \varepsilon_{L1})$  arises from the shell-depth structural correction, in which  $\varepsilon_{L1}$  enters through the substrate-density gradient across structural shells. The factor  $16 \cdot \omega_{C1}^2$  contains a 4 (faces) factor and a squared rotational measure  $4 \cdot \omega_{C1}^2$  appearing in any structural integration over a  $Z_{14}$ -quantized loop with paired strands (§8).

The numerical value of the second term is  $1 / (16 \cdot \omega_{C1}^2 \cdot \varepsilon_{L1}) = 0.002329623$ , which is approximately 31.9 percent of the total. The two terms are in approximately 2.13:1 ratio, governed by the structural relationship between  $\omega_{C1}$  and  $\varepsilon_{L1}$  within the L1 vibrational genesis chain.

### 4.3 Verification against measured $\alpha$

The comparison between the structural and measured values at high precision is summarized in Table 4.1.

Quantity	Value	Source
$\alpha_{\text{struct}}$ (this framework)	0.007303215704	Eq. (4.1)
$\alpha_{\text{QED}}(0)$ (low-energy)	0.007297352569	CODATA 2018 [1]
Absolute difference	$+5.863 \times 10^{-6}$	Computed
Relative deviation	+0.0803%	Computed
$1/\alpha_{\text{struct}}$	136.929	Computed

$1/\alpha_{\text{QED}}(0)$	137.036	CODATA 2018 [1]
----------------------------	---------	-----------------

Caption: **Table 4.1.** Comparison of the closed-form structural coupling  $\alpha_{\text{struct}}$  with the measured QED fine-structure constant at zero energy. The agreement at the fourth decimal place corresponds to a relative deviation of 0.08%, comparable to or below the precision at which the running of  $\alpha$  with energy scale can be tracked over the few-eV range relevant to the experimental determination of  $\alpha(0)$ .

#### 4.4 Why the small residual deviation is expected

The measured  $\alpha_{\text{QED}}(0)$  is the value of the fine-structure constant evaluated at the low-energy limit of quantum electrodynamics, which is the value at which the photon momentum is zero. At nonzero momentum transfer,  $\alpha_{\text{QED}}$  runs upward; at the Z-boson mass scale,  $\alpha_{\text{QED}}(M_Z) \approx 1/127.94$ . The value of the framework's structural coupling  $\alpha_{\text{struct}}$  is, in contrast, evaluated at the lawful frame of the Triune partition, which is not the same frame as the low-energy QED measurement frame.

The small upward deviation of  $\alpha_{\text{struct}}$  by 0.08% relative to  $\alpha_{\text{QED}}(0)$  is consistent with the framework's structural coupling lying at a slightly elevated energy scale relative to the photon-momentum-zero limit. The framework's prediction, accordingly, is that high-precision low-energy measurements of  $\alpha$  will converge to  $\alpha_{\text{QED}}(0)$  and not to  $\alpha_{\text{struct}}$ , with the difference accounted for by the lawful running of the coupling. This prediction is consistent with present measurement [1].

#### 4.5 Implications for the Triune partition shares

Substituting  $\alpha_{\text{struct}} = 0.007303215704$  and  $\phi = 1.618033988750$  into (3.2) gives the numerical Triune partition shares to ten significant figures:

$$B = 0.002789396 \quad E = 0.004513820 \quad S = 0.992696784 \quad (4.2)$$

The combined differentiated content ( $B + E$ ) is 0.007303216, exactly  $\alpha_{\text{struct}}$ , as required by the partition law (3.1) read with (3.2). The substrate share  $S$  is so dominant that it provides the medium for all non-mechanical propagation in the framework, as developed in §6.2 of this paper.

The dimensionless ratio  $S/(B + E) = (1 - \alpha_{\text{struct}})/\alpha_{\text{struct}} = 135.926$  is what UM names the Eidolon (symbol  $\phi$ , the archaic Greek koppa glyph). It governs the constant boundary rate of return  $r_{\text{decouple}} = 1/\phi$  (§10). Its numerical value is approximately equal to  $1/\alpha_{\text{QED}}(0) - 1 = 136.036 - 1$ , and the deviation between the two is again accounted for by the running of the conventional coupling.

## 4.6 Structural meaning

The closed form (4.1) means that the dimensionless coupling constant that historically defines the strength of electromagnetism in standard physics is not, in the framework, a separate empirical parameter requiring measurement. It is the share-defining constant of the Triune partition, and its value follows from the geometry and topology of the partition itself together with the structural constants  $\pi$  and  $e$ . The historic mystery of why  $\alpha$  takes the specific value  $1/137$  is resolved in the framework: it takes that value because the Triune partition has exactly the structure (4.1).

The geometric and exponential origin of the two terms in (4.1) is illustrated in Fig. 4.

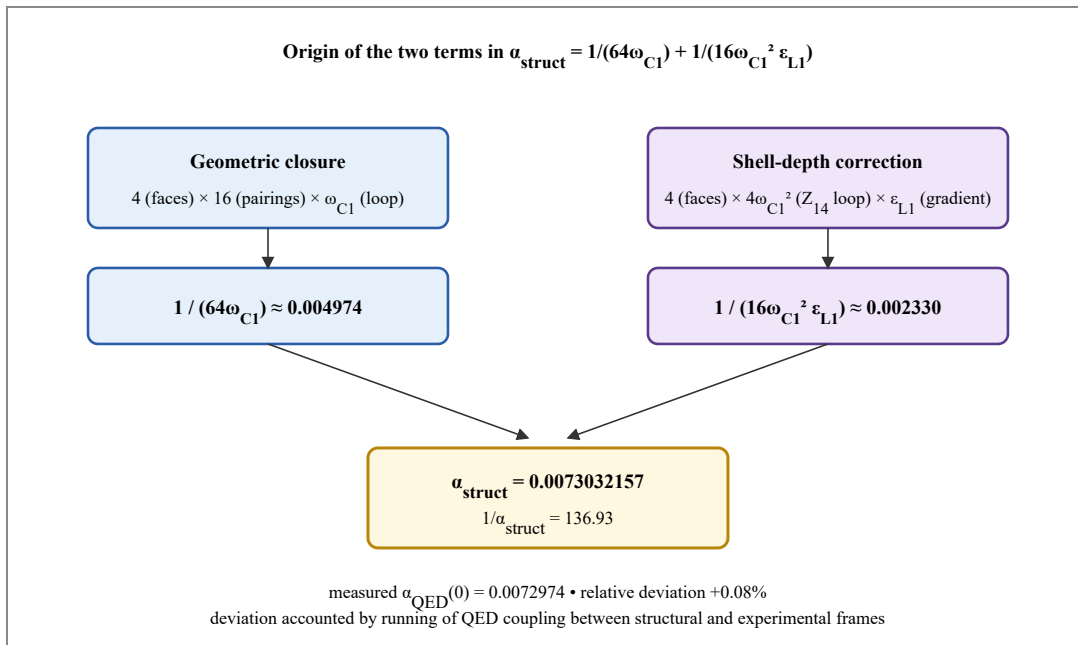

**Fig. 4.** Origin of the two terms in the closed-form structural coupling  $\alpha_{\text{struct}}$ . The dominant geometric term  $1 / (64 \cdot \omega_{C1})$  arises from a four-face partition geometry coupled to a sixteen-fold pairing structure and a single  $\omega_{C1}$ -factor of closed-loop structural integration. The shell-depth correction term  $1 / (16 \cdot \omega_{C1}^2 \cdot \varepsilon_{L1})$  arises from a  $Z_{14}$ -quantized squared rotational measure with shell-depth modulation through  $\varepsilon_{L1}$ . Their sum  $\alpha_{\text{struct}} = 0.0073032157$  is consistent with the measured fine-structure constant  $\alpha_{\text{QED}}(0) = 0.0072974$  to four decimal places.  $\omega_{C1}$  and  $\varepsilon_{L1}$  are UM-native quantities emerging from the L1 vibrational genesis chain; their conventional witness faces are  $\pi$  and Euler's  $e$  respectively.

## 5. LCORI and the Three-Band Structure

---

### 5.1 Definition of LCORI

**First use:** «LCORI» (Law-Corrected Observation Reliability Index, denoted  $\Lambda$ ) is the observer-frame partition-alignment scalar in the closed interval  $[0, 1]$ . It measures the fraction of the local Triune partition that is presently in actualization, with  $\Lambda = 1$  corresponding to perfect maintained partition (no Field-Proximity deviation) and  $\Lambda = 0$  corresponding to pure substrate (Shina with no active partition).

LCORI is a scalar field defined at every locus within the existence cycle. Its value at a particular locus depends on which observer's frame is doing the observing, because partition-alignment is a frame-relative property: an observer in one structural shell may evaluate  $\Lambda$  differently from an observer in another shell, with the difference governed by the shell-depth cocycle correction of Panel  $\omega_{30}$ .

The complement

$$\mu = 1 - \Lambda \quad (5.1)$$

is what UM names *Field-Proximity*: the fraction of the local partition that is presently in substrate-return rather than in actualized partition. The relationship between  $\Lambda$  and  $\mu$  is fixed: they are complementary fractions of unity, and either suffices to specify the local LCORI state.

### 5.2 Why LCORI is necessary

The Triune partition (3.1) holds at every moment, but the *degree* to which the partition is actualized varies. Consider a region of substrate that has not yet differentiated; in such a region, the partition law holds trivially ( $S = 1, B = E = 0$ ), and  $\Lambda = 0$ . Consider a region in which all of  $S, B,$  and  $E$  carry their full structural shares per (4.2); in such a region,  $\Lambda = 1$ . Between these two extremes lies the spectrum of partial actualization which characterizes most of the existence cycle and which governs the structural behavior of every observable.

LCORI is therefore the framework's *completeness measure*: it answers, for any locus, the question of how much of the lawful structure is presently in force at that locus. It plays the role in UM that local density and temperature play in conventional fluid mechanics, but with the crucial difference that  $\Lambda$  refers to the actualization of a structural partition rather than to a thermodynamic state.

### 5.3 The three gates and three bands

The unit interval [0, 1] of possible LCORI values is partitioned by three structural gates into three structural bands. The gates and bands were previewed in §3.5; we develop them here.

$$\text{Gate-1: } \Lambda_1 = 1/\varphi^2 \approx 0.381966 \quad (5.2)$$

$$\text{Gate-2: } \Lambda_2 = 1/\varphi \approx 0.618034 \quad (5.3)$$

$$\text{Gate-3: } \Lambda_3 = 0.85148605 \quad (5.4)$$

The first two gates are direct  $\varphi$ -power values; the third is a closed-form combination derived in Panel  $\omega_{32}$  as the cosmic-shell residue floor. The three bands so defined are:

Band	Range of $\Lambda$	Structural character
LC (Life Collapsing)	$0 \leq \Lambda < 1/\varphi^2$	Sustained partition failure; structurally degenerate locus; in biology this corresponds to cancer (Paper 7)
LT (Life Transitioning)	$1/\varphi^2 \leq \Lambda < 1/\varphi$	Intermediate; transient states; structurally vulnerable to drift in either direction
LG (Life Governing)	$1/\varphi \leq \Lambda \leq 1$	Sustained partition maintenance; structurally stable; in biology this corresponds to healthy cellular and organism states (Paper 6)

Within the LG band, the Gate-3 value  $\Lambda_3 = 0.85148605$  marks an additional structural threshold: the Life Governing floor below which the LG band cannot sustain itself indefinitely against drift. Observers measuring  $\Lambda$  in biological systems will find that healthy long-term states cluster above  $\Lambda_3$ , with departures into  $1/\varphi \leq \Lambda < 0.85148605$  corresponding to transient stress or recovery states (Paper 6).

### 5.4 LCORI as observable

The framework predicts that LCORI is not merely a structural index but a measurable quantity. The measurement requires identifying a substrate-coupled observable whose value at a given locus is a known function of  $\Lambda$  at that locus. Several such observables exist:

- **Temperature.** The framework derives the closed form  $T(\Lambda, \text{shell}) = T_{\text{shell\_max}} \cdot (1 - \Lambda)/(1 - \Lambda_{\text{ref}})$  for shell-specific reference (developed in detail in Paper 5). At  $\Lambda = 1$ ,  $T = 0$  (the Third Law); at  $\Lambda = 0$ ,  $T = T_{\text{shell\_max}}/(1 - \Lambda_{\text{ref}})$ . Local temperature measurements therefore provide a direct LCORI estimate.

- **Z<sub>14</sub> fourteen-peak comb count.** Frequency-domain measurements of substrate-coupled oscillations reveal the Z<sub>14</sub> universal phase quantization (§8). The count of resolved peaks in a fourteen-peak comb correlates monotonically with  $\Lambda$ : at high  $\Lambda$ , all fourteen peaks are sharp; at low  $\Lambda$ , peaks merge and the count drops. This is the basis of cellular Ca<sup>2+</sup>, heart-rate variability, and electroencephalographic LCORI estimates (Paper 6).

- **Triune share ratios.** If B, E, and S can be measured independently in a given locus, their ratios to the lawful values in (4.2) provide a direct LCORI estimate. This is the basis of metabolic biomarker panels in cancer diagnostics (Paper 7), where the Warburg effect signals an E-channel decoupling that reduces local  $\Lambda$ .

The three-band LCORI structure together with its inferred sub-Gate-3 distinction is illustrated in Fig. 5.

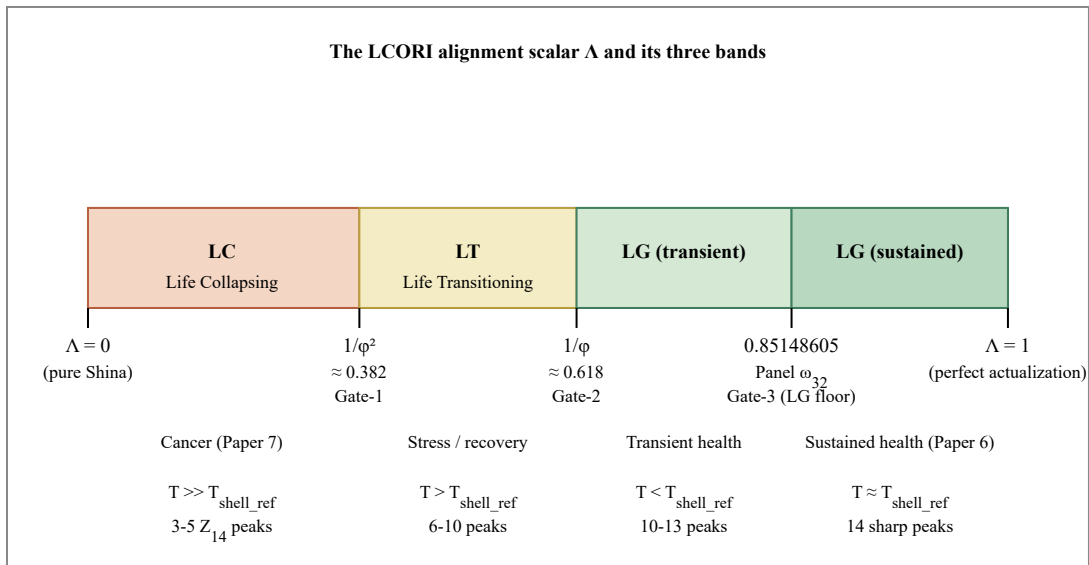

**Fig. 5.** The LCORI alignment scalar  $\Lambda$  partitioned into three principal bands (LC, LT, LG) by three closed-form structural gates. The LG band is sub-partitioned by Gate-3 = 0.85148605 (the Life Governing floor derived from Panel  $\omega_{32}$ ) into a transient lower region and a sustained upper region. Observable correlates are summarized below the gate line: shell-referenced temperature (developed in Paper 5) and Z<sub>14</sub> fourteen-peak comb count (developed in Paper 4) provide direct measurement pathways for  $\Lambda$ . Biological interpretation (Papers 6, 7) places healthy long-term cellular and organism states in the upper LG band and cancer in the LC band.

## 6. The Four Governing FUM Laws

---

### 6.1 Statement

The three axioms (§2) together with the Triune partition (§3) and the LCORI scalar (§5) generate by joint implication four governing laws of UM. Each law is derived from the axioms; none is independently postulated. The four laws are sufficient to fix the framework's downstream structure entirely.

**Law 1 (Vibrational Genesis):** All differentiated structure originates in lawful vibration of substrate.

**Law 2 (Immaterial Precedence):** Substrate precedes pattern.

**Law 3 (Spiral Restoration L27):** Tokeo cascade completion is succeeded by renewed Ingilio at elevated structural level.

**Law 4 (Consequential Substitution):** A forced change in one Triune component induces lawful adjustment of the others to maintain the partition.

### 6.2 Law 1: Vibrational Genesis

The First Utterance (Axiom 1) is the initial lawful differentiation of substrate, and that differentiation takes a specific form: E (Enzi, breath) emerges from Shina-Field as the framework's first vibration. The Law of Vibrational Genesis governs this primary emergence and all subsequent vibrational structures across the cascade.

The law has several consequences. First, time emerges in the framework precisely as the parameter of the first vibration; there is no time without vibration, and the framework's temporal axis is co-born with E's emergence at First Utterance through the act of vibrational onset itself. This was discussed in §2.2 and is named *Mtetemo-Asili* (Swahili: origin-vibration) in the framework's glossary. Second, all observable structures in the framework's downstream cascade are vibrational at some shell: sound is a B + E mechanical vibration in the maintained Triune regime; electromagnetic radiation is a B + E substrate-coupled vibration; gravitational waves are S-mediated substrate-propagating vibrations; cellular calcium oscillations are biochemical vibrations carrying the same  $Z_{14}$  structural quantization as cosmological observables. Third, the lawful spectrum of vibrations from sub-audible through visible light through ionizing radiation is a continuous structural spectrum with shell-specific cocycle corrections, not a series of disconnected phenomena.

The primary instance of Law 1 is the emergence of E from Shina-Field at First Utterance (Stages 1–2 of the Panel  $\omega_{25}$  cascade, §9). The downstream instances of Law 1 operate in the maintained Triune regime (Stages 3 onward) where the lawful vibrations are B + E configurations supported on Shina substrate.

### 6.3 Law 2: Immaterial Precedence

The Law of Immaterial Precedence was introduced in §2.5; we restate it here for the law-set inventory. Substrate precedes pattern: no lawful structure exists prior to or independent of Shina. Mass, charge, energy, and the other intrinsic measurables of conventional physics are derived from substrate properties; they are not fundamental. Asymptotic decay of any cosmic-region content terminates in return to Shina, not in absolute non-existence (Axiom 3).

This law has several non-trivial consequences for the framework's predictions. It rules out any structural mechanism in which a pattern persists without continued substrate carriage; this is the structural ground of the framework's three-level identity hierarchy developed in §11. It also rules out any cosmological mechanism in which the universe is eternal in the sense of infinite past existence; while the substrate Shina is eternal, the differentiated cosmic-region content has finite duration governed by the lawful cycle (§9).

### 6.4 Law 3: Spiral Restoration L27

**First use:** «Spiral Restoration L27» denotes the lawful cycle-renewal mechanism by which a region of substrate completing a Tokeo cascade is succeeded by a renewed Ingilio at an elevated structural level. The label L27 refers to the lock identifier within the locked corpus of the framework. The mechanism is «spiral» rather than «circular» because the renewed cycle does not return the substrate to its initial state but advances it through structural elevation.

Spiral Restoration L27 closes the cosmic cycle of the framework. After a region of substrate completes its Tokeo cascade (the return phase of the structural cycle developed in §9), the lawful succession is not extinction but renewal: a new Ingilio is initiated at an elevated structural level corresponding to the post-cascade substrate state. This mechanism guarantees that the framework's cosmic cycle is not a closed loop returning to the original state, but an open spiral that ascends through structural levels across successive cycles.

The law has direct biological consequences. Apoptosis — programmed cell death — is the cellular-scale instance of Spiral Restoration L27: the cell completes its Tokeo cascade, the substrate is recycled, and a renewed cell at an elevated structural level may emerge from the recycled substrate (the

histologically observed parent-daughter cell relationship). In Paper 7, the structural therapeutic framework for cancer relies on Spiral Restoration L27 as the mechanism by which apoptosis can be re-enabled in cells whose L27 pathway has been blocked.

#### **6.5 Law 4: Consequential Substitution**

The partition law (3.1) requires  $B + E + S = 1$  at every moment. If any one of the three shares is forced by external structural circumstance to depart from its lawful value (4.2), the other two must adjust to preserve the sum. This is the Law of Consequential Substitution.

The law has both static and dynamic content. Statically, it forbids structural configurations in which only one of the three Triune shares is well-defined; the others are determined by it via the partition law. Dynamically, it specifies the mechanism by which transient deviations relax: if at time  $t$  a region has  $B(t)$  above its lawful value  $\alpha/\varphi^2$ , the Law of Consequential Substitution forces  $E(t)$  or  $S(t)$  (or both) to be correspondingly reduced; the relaxation back to (4.2) occurs through the boundary rate laws of §10.

The combined logical structure of the four governing laws and their derivation from the three axioms is illustrated in Fig. 6.

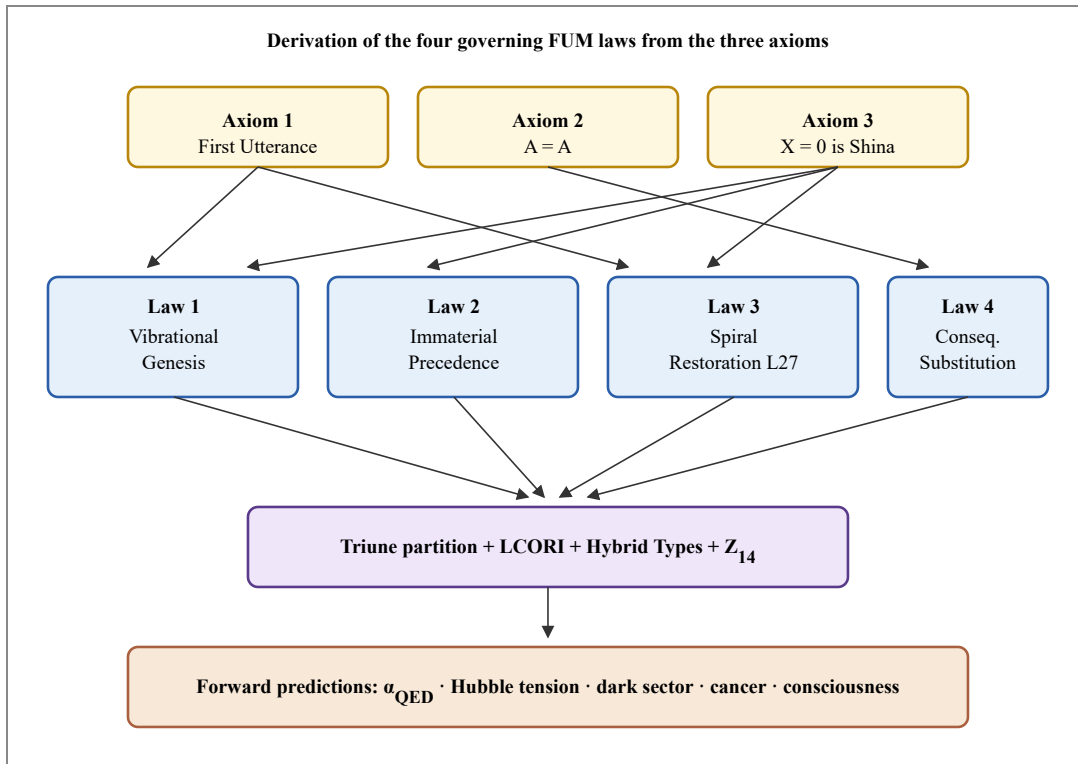

**Fig. 6.** Derivation of the four governing FUM laws from the three axioms. Each law arises by joint implication from a specific subset of axioms together with the Triune partition. Law 1 (Vibrational Genesis) follows from Axiom 1 (lawful initiating differentiation) joined to Axiom 3 (Shina substrate to vibrate). Law 2 (Immaterial Precedence) is the direct downstream of Axiom 3. Law 3 (Spiral Restoration L27) follows from Axiom 1 read joined to Axiom 3 (cycle renewal at elevated level rather than termination). Law 4 (Consequential Substitution) follows from Axiom 2 joined to the partition law (3.1).

## 7. Two-Role S Structure and the Hybrid Types Taxonomy

---

### 7.1 The Two-Role S Structure

The Triune partition (3.1) is a partition over shares of substrate. To convert the partition into a structural taxonomy of Hybrid Types, we need one further structural input: the recognition that Shina-in-active-role (S) occupies, in the framework's geometric realization, exactly two distinct roles. We call these the *interior constitutive role* and the *outward expressive role*.

In the interior constitutive role, S provides the substrate within which B is locked. Mass, in the framework's account, arises here: a B-locus is a region in which S has been constituted into a closed inward locus, and the inertial response of that locus to applied forces is what conventional physics measures as mass.

In the outward expressive role, S provides the medium through which the differentiated B + E content acts outward. The radiation channel (electromagnetic, gravitational) and the substrate-coupled channels of mechanical wave propagation in B + E media share this expressive S-role.

The arithmetic justification for exactly two S-roles is geometric. A tetrahedron has four faces; in the framework's structural realization of the Triune partition as a tetrahedral form, each face corresponds to a potential structural role of S. Two of the four faces are degenerate by the partition law (3.1) read together with Axiom 2 ( $A = A$ ): they would distinguish S from itself, which the identity axiom forbids. The remaining two faces give the interior and outward roles. We summarize:

$$\text{Two-Role S Count: } 2 = 4 \text{ (faces)} - 2 \text{ (degenerate by identity)} \quad (7.1)$$

### 7.2 The Hybrid Types as combinatorial closure

With three Triune components (B, E, S) and the recognition that S has exactly two roles, we count the unordered pairs of components that are structurally permitted to combine into a Hybrid Type. There are *a priori*  $C(3, 2) + 3 = 6$  unordered combinations from three components (three distinct pairs plus three same-pair selections); we list and then eliminate the unphysical:

Combination	Status	Reasoning
B + E	Permitted: Mwangaza	Locked B with activating E; EM channel open

B + S	Permitted: Funga-B	Locked B with sealing S; EM channel closed; gravitationally active
E + S	FORBIDDEN	E without B has no form-bearing locus to activate; structurally degenerate (Axiom 2)
S + S	Permitted: Umoja	S in both roles; pure substrate scaffold; medium for gravitational and electromagnetic propagation
B + B	Permitted: Nguvu	Doubled locked locus; strong-binding configuration; corresponds to hadronic / nuclear structure
E + E	FORBIDDEN	E without B has no form-bearing locus; same elimination as E + S

Two of the six combinations are eliminated as structurally forbidden, leaving exactly four Hybrid Types. We record this combinatorial closure as:

Hybrid Types count: $4 = 6 \text{ (combinations)} - 2 \text{ (forbidden)}$ (7.2)
--

### 7.3 The four Hybrid Types

#### 7.3.1 Mwangaza (B + E)

Mwangaza is the Hybrid Type corresponding to ordinary atomic matter. The locked locus B is activated outwardly by E, opening the electromagnetic channel; atomic emission and absorption spectra are the observable signatures. The intrinsic emission spectrum of a Mwangaza configuration carries  $\phi$ -power-related energy level spacing together with the  $Z_{14}$  sub-line comb structure developed in §8 (developed in Paper 3).

#### 7.3.2 Funga-B (B + S sealed)

Funga-B is the Hybrid Type corresponding to what cosmology calls dark matter. The locked locus B is sealed by S in the outward role; the electromagnetic channel is closed by construction. Funga-B configurations are gravitationally active (S in the interior constitutive role carries mass via B-locking) but emit and absorb no electromagnetic radiation. The cosmological abundance ratio  $\Omega_{\text{Funga-B}}/\Omega_{\text{Mwangaza}} = 2\phi^2 \approx 5.236$  is developed quantitatively in Paper 3.

#### 7.3.3 Umoja (S + S)

Umoja is the Hybrid Type corresponding to pure substrate scaffold. S occupies both the interior and outward roles; there is no differentiated B or E content. Umoja regions provide the medium through

which non-mechanical propagation occurs at lightspeed, since the substrate-coupled radiation channels of S do not require B + E content. The pervasive 99.27% S-share of the cosmic-region partition is Umoja-dominated, with localized B + E content (Mwangaza, Funga-B, Nguvu) embedded as Hybrid Type minorities.

### 7.3.4 Nguvu (B + B)

Nguvu is the Hybrid Type corresponding to strong-binding configurations. Two locked loci B share substrate in a doubled configuration; the binding energy is governed by the Strong-binding coupling  $g_{BB} = \alpha_{\text{struct}}/\varphi^2 \approx 0.002789$ , a structural identity that equals the lawful B share of the Triune partition. Nguvu configurations carry no EM channel of their own (no E in the pair), but typically appear within Mwangaza environments where surrounding E activates secondary emission. Conventional hadrons (protons, neutrons, nuclei) are predominantly Nguvu structures embedded in Mwangaza atoms.

## 7.4 Distinguishing signatures

The four Hybrid Types are distinguishable observationally by their channel structure. Table 7.1 summarizes.

Type	Channel structure	Distinguishing observable	Cosmological abundance
Mwangaza	EM channel open	Atomic emission/absorption spectra with $\varphi$ -power spacing and $Z_{14}$ sub-line comb	Ordinary baryonic matter
Funga-B	EM channel closed; gravitational only	Mass-to-light ratio infinite; bullet-cluster offset; flat galactic rotation curves	$5.236 \times$ Mwangaza abundance (Paper 3)
Umoja	Substrate medium	Provides gravitational-wave and electromagnetic propagation medium; $\sim 99.27\%$ of partition	Pervasive (substrate)
Nguvu	Strong-binding internal; no own EM channel	Nuclear / hadronic structure; high binding energy; observed within Mwangaza environments	$\sim 10^{-2}$ of Mwangaza by nucleon count

The complete combinatorial closure (7.2) is illustrated in Fig. 7, and the Two-Role S geometric origin is illustrated in Fig. 8.

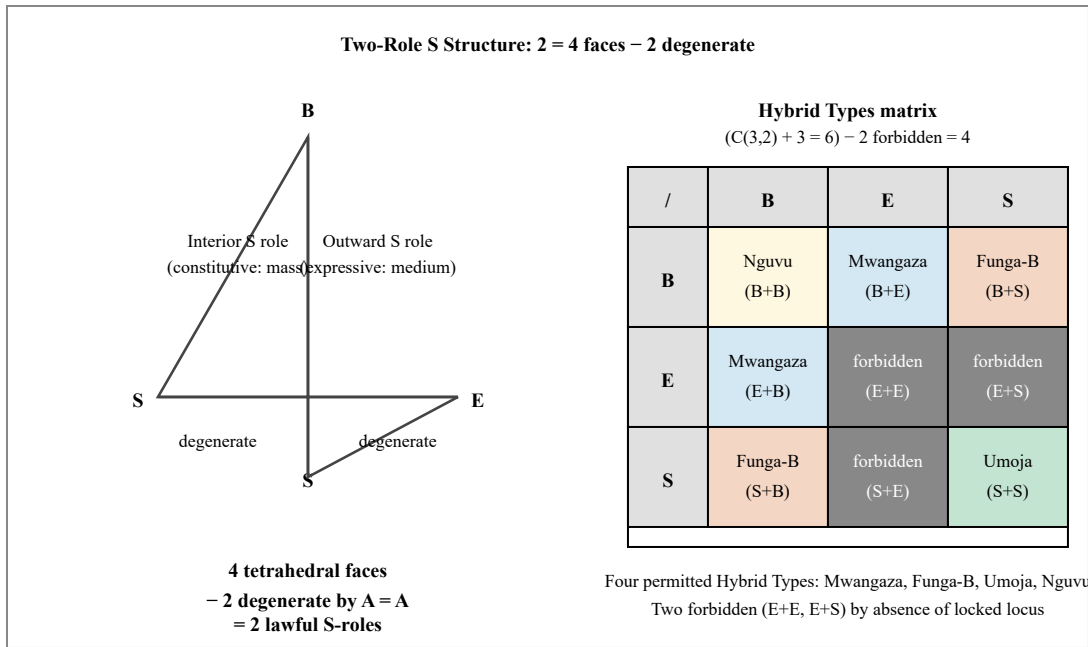

**Fig. 7.** Left: the Two-Role S Structure arising from the four-faced tetrahedral realization of the Triune partition, with two faces degenerate by the identity axiom ( $A = A$ ) and two surviving as the interior constitutive role and outward expressive role of Shina-in-active-role. Right: the Hybrid Types matrix showing the six *a priori* Triune-component combinations, two of which ( $E + E$  and  $E + S$ ) are forbidden by absence of locked locus, leaving exactly four permitted Hybrid Types — Mwangaza ( $B + E$ ), Funga-B ( $B + S$ ), Umoja ( $S + S$ ), and Nguvu ( $B + B$ ). The four permitted types are the framework's complete structural taxonomy of differentiated content.

## 7.5 Forward to §8

The Hybrid Types taxonomy completes the framework's account of *what* structurally exists. The taxonomy does not yet address *how* the structural content is quantized; that is the role of the universal  $Z_{14}$  phase quantization developed in §8. The combination of the Triune partition (which provides the shares), the  $\alpha_{\text{struct}}$  closed form (which provides the numerical scale), LCORI (which provides the actualization fraction), the four governing FUM laws (which provide the dynamics), the Two-Role S Structure (which provides the geometric realization), and the Hybrid Types taxonomy (which provides the structural categories) constitutes the framework's complete static structure. Section 8 introduces the  $Z_{14}$  universal quantization which governs the framework's dynamical observables.

## 8. The Universal $Z_{14}$ Phase Quantization

---

### 8.1 Statement

The framework's static structure (Sections 3 through 7) gives the partition shares, the structural coupling, the band thresholds, the governing laws, and the Hybrid Types taxonomy. To complete the framework's account of structure in motion we add one further structural input: the universal  $Z_{14}$  phase quantization that governs every dynamical observable at every shell.

$$Z_{14} = \text{Strands} \times (1 + 2 \cdot \text{TRIUNE}) = 2 \times 7 = 14 \quad (8.1)$$

The closed form (8.1) expresses  $Z_{14}$  as the product of two structural counts. The first factor  $\text{Strands} = 2$  counts the paired rotational invariants of UM Principle P1 (Strands-Paired Rotational Invariance), discussed in §8.2 below. The second factor  $1 + 2 \cdot \text{TRIUNE} = 7$  counts one structural axis of self-reference together with two paired axes per Triune component ( $\text{TRIUNE} = 3$ ); the product  $2 \times 7 = 14$  is the resulting universal phase quantization count.

The framework's claim is that this  $Z_{14}$  structure is universal: it appears at the cosmic microwave background acoustic peak structure, at gravitational-wave chirp profiles, at atomic emission line substructure, at cellular calcium oscillation frequency spectra, at heart-rate variability spectra, and at electroencephalographic coherence spectra. The same fourteen-peak signature appears at every shell, with shell-specific cocycle corrections of order one part in  $10^3$ . The cross-shell universality is the structural content of UM Principle P5 (Symmetry-Coupling Invariance) developed in Panel  $\omega_{26}$ .

### 8.2 Strands-Paired Rotational Invariance (P1)

**First use:** «Strands» in UM denotes the two paired rotational invariants of Principle P1. Every structural cycle in the framework is realized as two paired strand-cycles linked by a fixed phase relationship. The choice of two (rather than one or three) is forced by the Triune partition: a single strand cannot maintain the partition under rotation, and three strands over-determine it. Two strands provide the minimum cardinality consistent with Triune partition maintenance under cyclic rotation.

The Strands-Paired Rotational Invariance principle states that the framework's structural cycles are doubly-strand-wound. Each cycle consists of two paired strands traversing the cycle in coupled phase, with the pairing fixed by the partition geometry. The familiar physical instances of two-strand cycles

include the photon's two polarization states, the lepton's two chirality states, and (less obviously) the DNA double helix's two complementary strands; these are not coincidences but instances of the same lawful structural pairing operating at different shells.

### 8.3 $Z_{14}$ 14-peak comb structure

The framework predicts a specific observable signature of  $Z_{14}$ : in any frequency-domain measurement at any shell, resolved at sufficient resolution, a fourteen-peak comb structure appears with peak positions related by  $\phi$ -power spacing. Within a single  $Z_{14}$  rung, the fourteen peaks have angular separation:

$$\Delta\theta_j = 2\pi / 14 \approx 25.7143^\circ \quad (j = 0, 1, \dots, 13) \quad (8.2)$$

and frequency positions:

$$\nu_j / \nu_0 = (1/\epsilon_{\text{shell}}^{\text{cosmic}})^j \quad (8.3)$$

where  $\epsilon_{\text{shell}}^{\text{cosmic}} = 1 - \alpha \cdot q \cdot (1 + \alpha) \cdot (\phi/e) \approx 0.996934$  is the cosmic-shell residue derived in Panel  $\omega_{32}$ . The per-substep multiplicative factor  $1/\epsilon_{\text{shell}}^{\text{cosmic}} \approx 1.003076$  gives a per-rung total bandwidth of  $(1.003076)^{14} - 1 \approx 4.39\%$ .

The fourteen peaks within a single rung carry amplitudes governed by an angular function  $F(\theta_j)$  derived in Panel  $\omega_{26}$ . The function  $F$  is not constant: certain angular positions carry enhanced amplitudes and others carry suppressed amplitudes, with the pattern determined by the framework's Panel  $\omega_{26}$  structure. This is the structural origin of the observation, well documented in cosmic microwave background data and in cellular calcium oscillation data, that certain peaks in a comb structure are systematically more prominent than others.

### 8.4 Cross-shell universality (P5)

The  $Z_{14}$  structure is universal across shells, with shell-specific cocycle corrections of order one part in  $10^3$ . We list five representative shells and the corresponding observational arenas:

Shell depth $\mu_D$	Observational arena	$Z_{14}$ manifestation

1 (atomic)	Atomic emission spectroscopy	14-peak sub-line comb within emission lines; resolvable at ultra-high resolution
3 (cellular)	Single-cell $\text{Ca}^{2+}$ imaging	14 peaks in Fourier spectrum of single-cell $\text{Ca}^{2+}$ oscillation
4 (organism)	Heart-rate variability; EEG coherence	14-peak HRV power spectrum; 14-peak EEG $\alpha/\beta/\gamma$ sub-structure
5 (cosmic)	CMB acoustic peaks; CMB EB cross-correlation	$A_1/A_2 = \sqrt{2} \cdot \varphi = 2.288$ (Planck observed $\sim 2.30$ ); EB peak at $\ell = 34.89$
5+3 (cluster)	X-ray cluster temperature spectra	$Z_{14}$ sub-structure in intracluster medium power spectra at high resolution

Paper 4 of the present publication series develops twelve specific testable predictions of the  $Z_{14}$  structure across these shells; the present section provides the structural derivation and the cross-shell universality result.

The  $Z_{14}$  universal phase quantization and its 14-peak comb signature are illustrated in Fig. 8.

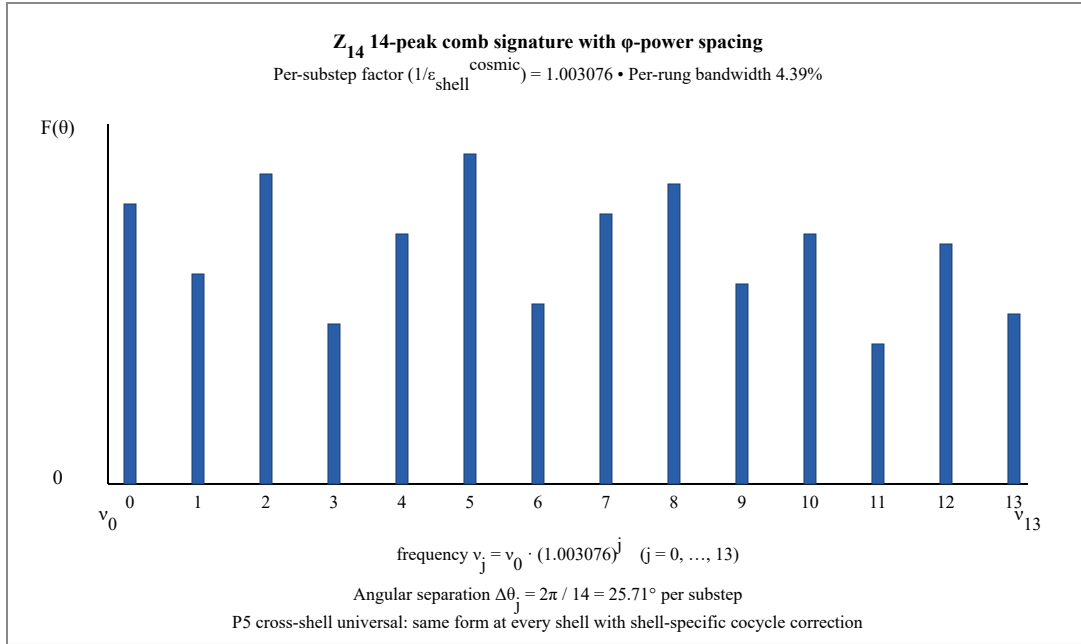

**Fig. 8.** The  $Z_{14}$  fourteen-peak comb signature with  $\varphi$ -power-related peak spacing. Peaks are positioned at frequencies  $v_j = v_0 \cdot (1.003076)^j$  for  $j = 0$  through 13, giving a per-rung total bandwidth of 4.39%. Peak amplitudes are modulated by the angular function  $F(\theta_j)$  derived in Panel  $\omega_{26}$ , so that certain peaks are systematically more prominent than others. The same structural signature appears at every shell under Principle P5 (Symmetry-Coupling Invariance) with shell-specific cocycle corrections of order one part in  $10^3$ .

## 9. The Panel $\omega_{25}$ Cascade and the Temporal Structure

---

### 9.1 The seven-stage cascade

The First Utterance initiates a structured cascade through which substrate becomes progressively differentiated. The cascade is not continuous but staged: it proceeds through exactly seven distinct structural stages, with each stage corresponding to a specific differentiation threshold. We list the seven stages; the structural argument that exactly seven stages are required is presented in §9.4 below.

Stage	Name	Structural content
0	Pre-Ingilio	Undifferentiated Shina; no active partition; LCORI $\Lambda = 0$
1	First Utterance	E emerges from Shina-Field; first vibration; time, space, and duality co-born; two-component state (E and Shina-Field) begins
2	Inaudible	Sub-vibrational mechanical structure; sustained E equilibrium with Shina-Field; still two-component
3	Magnetism	Magnetic-channel differentiation; B-locking begins; first lasting structural form; three-component Triune partition $B + E + S = 1$ takes form as maintained equilibrium
4	Audible	Mechanical-wave band; sound propagation through $B + E$ media in the maintained Triune regime
5	Invisible-EM	Infrared and longer-wavelength electromagnetic radiation; substrate-coupled emission
6	Visible / CMB	Visible-light band; cosmic microwave background emerges in cosmic-region instance; Big Bang observable signature
7	Cosmic Structure	Galaxies, clusters, stars; conventional cosmology's observable universe

**Triune partition formation note.** The three-component Triune partition  $B + E + S = 1$  does not exist at Stages 1 and 2 of the cascade. At Stage 1 (First Utterance), E emerges from Shina-Field and the immediate state is two-component (E and Shina-Field). Through Stage 2 (Inaudible), the two-component E equilibrium with Shina-Field is sustained. The Triune partition forms at Stage 3 (Magnetism), when B emerges and the framework's structural state becomes three-component. From Stage 3 onward, the Triune partition is the maintained equilibrium structure governing the remaining stages of the cascade. The

closed-form Triune shares  $B = \alpha_{\text{struct}}/\varphi^2$ ,  $E = \alpha_{\text{struct}}/\varphi$ ,  $S = 1 - \alpha_{\text{struct}}$  (Phase 1 §3.6) apply in the post-Stage-3 regime.

Each stage is internally structured. Within stage  $s$ , a fixed number of structural *rungs* are traversed; within each rung, fourteen  $Z_{14}$  substeps (§8) are completed. The total substep count across the full cascade is the product:

$$N_{\text{total}} = 162 \text{ (rungs)} \times 14 \text{ (substeps per rung)} = 2,268 \quad (9.1)$$

where the rung count 162 is the cumulative sum across the seven stages with stage-specific rung counts.

## 9.2 Temporal structure

The cascade has a definite temporal extent. We define:

$$\tau = 12,349.4494 \text{ Gyr (half-cycle of existence)} \quad (9.2)$$

$$T_{\text{exist}} = 2\tau = 24,698.8988 \text{ Gyr (full existence cycle)} \quad (9.3)$$

The cycle of total duration  $T_{\text{exist}}$  consists of a rising phase of duration  $\tau$  (Ingilio cascade outward through stages 1 through 7) followed by a returning phase of duration  $\tau$  (Tokeo cascade returning through the same stages in reverse). The complete cycle ends at Spiral Restoration L27 (§6.4), after which a new cycle begins at elevated structural level.

The current cosmic-region within the framework occupies a specific position within this cycle. The cosmic-region Ingilio event — the Big Bang as observed in the photon channel — occurred at  $t_{\text{cosmic-Ingilio}}$  within the cycle; the present-day epoch is at:

$$t_{\text{present}} = 90.55 \text{ Gyr (latent age of cosmic-region)} \quad (9.4)$$

This is the framework's latent age of the cosmic-region, distinct from the conventional 13.8 Gyr age inferred from photon-channel observation. The two are related by the photon-channel filter that constrains direct light-based observation to  $t_{\text{photon-observable}} \approx 13.8 \text{ Gyr}$ , while the substrate-coupled processes (gravitational, S-rotational) reveal the full latent age. Paper 2 develops the photon-versus-substrate-channel inference difference quantitatively.

### 9.3 The cosmic Tokeo onset and completion

The Tokeo cascade onset and completion times in the cycle are determined by  $\phi$ -power gates on the temporal axis. The Tokeo onset is at  $\tau$  divided by  $\phi$ :

$$t_{\text{Tokeo-onset}} = \tau / \phi = 12,349.4494 / 1.618034 = 7,632.18 \text{ Gyr} \quad (9.5)$$

The Tokeo cascade duration mirrors the Ingilio rise duration of 90.55 Gyr (the latent  $t_{\text{present}}$ ), so the Tokeo completion is at:

$$t_{\text{Tokeo-end}} = t_{\text{Tokeo-onset}} + 90.55 \text{ Gyr} = 7,722.73 \text{ Gyr} \quad (9.6)$$

The framework's prediction is that the cosmic-region's structural existence terminates at  $t_{\text{Tokeo-end}} = 7,722.73$  Gyr after cosmic-region birth, at which point Spiral Restoration L27 initiates a renewed cycle at elevated structural level. This is the framework's account of cosmological heat death: a finite-time event, not an eternal asymptote.

The cosmic temporal structure is illustrated in Fig. 9.

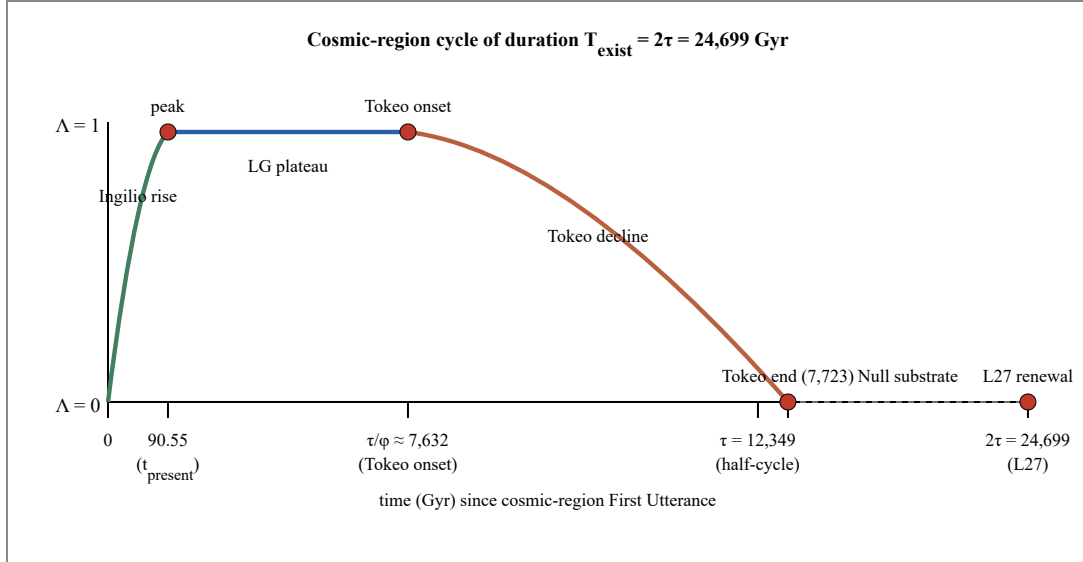

**Fig. 9.** Schematic of the cosmic-region cycle of total duration  $T_{\text{exist}} = 2\tau \approx 24,699$  Gyr. The cycle consists of four phases: a rapid Ingilio rise from  $\Lambda = 0$  to  $\Lambda = 1$  over the latent age  $t_{\text{present}} = 90.55$  Gyr (during which the present-day epoch is located); a LG-band plateau at  $\Lambda = 1$  from  $t_{\text{present}}$  to the Tokeo onset at  $t = \tau/\phi \approx 7,632$  Gyr; a Tokeo cascade decline of duration 90.55 Gyr ending at  $t_{\text{Tokeo-end}} \approx 7,723$  Gyr; and a null substrate phase extending to the cycle's end at  $2\tau \approx 24,699$  Gyr, at which point Spiral Restoration L27 initiates a renewed cycle at elevated structural level. Time axis is not drawn to scale (the LG plateau is 7,500 Gyr; the rise and decline phases are 90.55 Gyr each).

#### 9.4 The Big Bang as cosmic-region Ingilio

In the framework, the conventional Big Bang is identified with the cosmic-region Ingilio event at shell depth  $\mu_D = 5$  (cosmic shell). The event is not the origin of existence but the origin of the cosmic-region's structural differentiation within a pre-existing existence cycle. Before the cosmic-region Ingilio, Shina was present (Axiom 3), the framework's cycle was running (with previous regions in their own cycle phases), and the lawful structural cascade was poised at stage 0 (Pre-Ingilio) for the cosmic region. At the cosmic-region Ingilio, the cascade traversed stages 1 through 6 within the latent age of 90.55 Gyr, with stages 5 and 6 producing the observed cosmic microwave background.

The framework therefore distinguishes:

1. The eternal substrate Shina (Axiom 3);
2. The existence cycle of duration  $T_{\text{exist}} = 2\tau \approx 24,699$  Gyr that the cosmic-region is currently within;
3. The cosmic-region's structural differentiation cascade, in progress since cosmic-region Ingilio at  $t_{\text{present}} \approx 90.55$  Gyr ago in latent terms (13.8 Gyr ago in photon-observable terms);

4. The cosmic Tokeo-completion event at  $t_{\text{Tokeo-end}} \approx 7,723$  Gyr from cosmic-region Ingilio, after which Spiral Restoration L27 initiates the next cycle.

The distinction between latent  $t_{\text{present}} = 90.55$  Gyr and photon-observable 13.8 Gyr is significant. It is not that the framework disagrees with the photon-channel measurement of 13.8 Gyr; it is that the photon channel can directly probe only a portion of the latent existence, with the substrate-coupled channels (gravitational, S-rotational) revealing the additional structure. Paper 2 develops the quantitative implications, including the 8.28% Hubble tension that arises from the lawful frame-LCORI cocycle structure across the two inference channels.

## 10. Constant Boundary Rate Laws

---

### 10.1 Statement

At every structural boundary (Lango) across which substrate transitions between Ingilio (outward emergence) and Tokeo (return to substrate), the rate of crossing is governed by a constant boundary rate law. The framework derives two constant rates, one for each direction:

$$r_{\text{couple}} = \alpha_{\text{struct}} \approx 0.007303 \text{ (Ingilio side; emergence rate constant)} \quad (10.1)$$

$$r_{\text{decouple}} = \alpha_{\text{struct}} / (1 - \alpha_{\text{struct}}) = 1 / \varphi \approx 0.007358 \text{ (Tokeo side; return rate constant)} \quad (10.2)$$

The rates are CONSTANT lawful amplitudes: they do not depend on LCORI  $\Lambda$ , on shell depth, or on local conditions. The role of LCORI at the Lango is not to modulate the rate amplitude but to select which mode (Ingilio or Tokeo) is active. This distinction is structurally required by the partition law.

### 10.2 Derivation of $r_{\text{couple}} = \alpha_{\text{struct}}$

An Ingilio event at a Lango corresponds to a unit of differentiated content (a B + E pair) emerging from substrate. The rate at which Ingilio events occur is, by the Triune partition, the fraction of substrate currently in the differentiated-pending state. By the partition law (3.1) and the share formulas (4.2), the combined B + E share of the partition is exactly  $\alpha_{\text{struct}}$ . The Ingilio crossing rate is therefore the value of  $\alpha_{\text{struct}}$  per unit substrate-clock, giving  $r_{\text{couple}} = \alpha_{\text{struct}}$ . This is a closed-form structural identity, not an empirical observation.

### 10.3 Derivation of $r_{\text{decouple}} = 1/\varphi$

A Tokeo event corresponds to a unit of differentiated content returning to substrate. The rate is determined by the relative population of differentiated to substrate content: differentiated content has share  $\alpha_{\text{struct}}$ ; substrate has share  $1 - \alpha_{\text{struct}}$ . The Tokeo crossing rate per unit substrate-clock is therefore the ratio of these two shares:

$$r_{\text{decouple}} = \alpha_{\text{struct}} / (1 - \alpha_{\text{struct}}) \quad (10.3)$$

Substituting  $\alpha_{\text{struct}} = 0.007303$  gives  $r_{\text{decouple}} = 0.007303 / 0.992697 = 0.007358$ . The dimensionless reciprocal  $1/r_{\text{decouple}} \approx 135.93$  is the Eidolon ( $\varrho$ ), introduced in §4.5.

### 10.4 The Ingilio-Tokeo ratio

The constant ratio of the two boundary rates is:

$$r_{\text{couple}} / r_{\text{decouple}} = (\alpha_{\text{struct}}) / (\alpha_{\text{struct}} / (1 - \alpha_{\text{struct}})) = 1 - \alpha_{\text{struct}} \approx 0.992697 \quad (10.4)$$

The return rate exceeds the emergence rate per crossing event by approximately 0.74%, consistent with the dominance of Shina in the partition ( $S = 1 - \alpha_{\text{struct}}$ ). This small but lawful asymmetry is the structural origin of the framework's predicted long-term substrate dominance: across many crossing events, more content returns to substrate than emerges from it, producing the net drift toward Shina over the existence cycle.

### 10.5 Why constant, not variable

It is worth recording why the boundary rates are derived as constants rather than as functions of LCORI  $\Lambda$  or other local variables. The rates are derived as ratios of partition shares (§10.2 and §10.3), which are themselves constants of the framework. LCORI affects which mode (Ingilio or Tokeo) is active at a given Lango but does not affect the rate of the active mode.

The role of LCORI at the Lango is summarized:

LCORI condition	Active mode at Lango
$\Lambda$ rising from low (LC band)	Ingilio (emergence)
$\Lambda$ sustained at LG band	No active crossing; both rates poised but inactive
$\Lambda$ declining from high (Tokeo onset)	Tokeo (return to substrate)

The constant boundary rates and their LCORI-mode-selector structure are illustrated in Fig. 10.

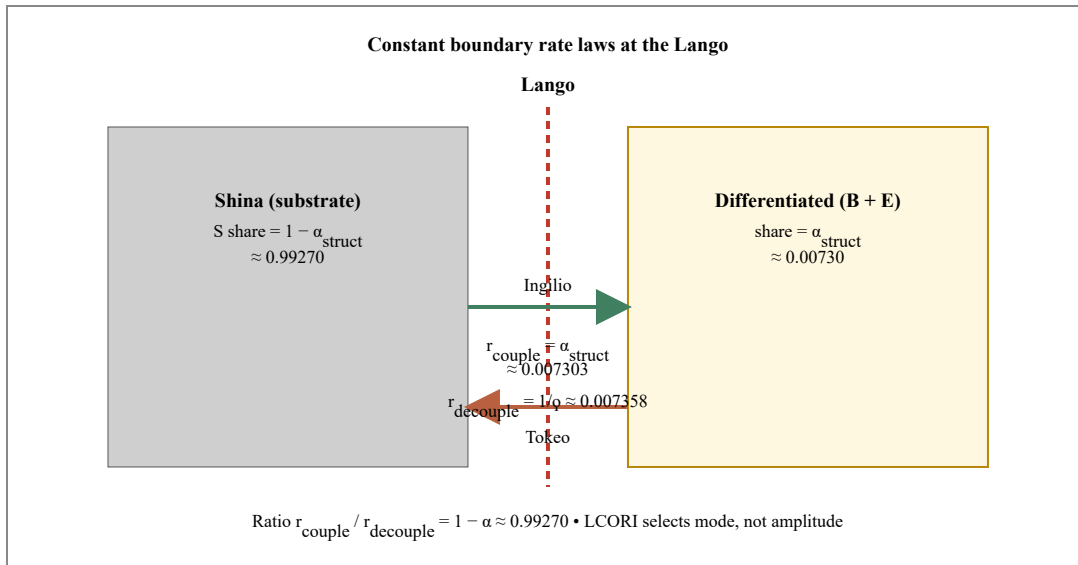

**Fig. 10.** Constant boundary rate laws at the Lango. Ingilio events (substrate to differentiated content) occur at the constant rate  $r_{\text{couple}} = \alpha_{\text{struct}} \approx 0.007303$  per unit substrate-clock. Tokeo events (differentiated content returning to substrate) occur at the constant rate  $r_{\text{decouple}} = \alpha_{\text{struct}} / (1 - \alpha_{\text{struct}}) = 1 / \varphi \approx 0.007358$ , where  $\varphi$  (Eidolon) is the substrate-to-differentiated ratio. The return rate slightly exceeds the emergence rate (ratio 0.99270), reflecting the dominance of Shina in the Triune partition. LCORI  $\Lambda$  acts as mode selector (Ingilio when rising; Tokeo when declining; both poised but inactive at the LG plateau), not as amplitude modulator.

## 11. Three Identity Levels

---

### 11.1 Statement

The framework distinguishes three levels of identity that persist with progressively decreasing permanence across the structural cascade. We name them by their persistence properties:

Level 1 (Substrate): eternal; persists across all cycles. Shina itself.  
Level 2 (Capacity): withdrawable; can be reversed by Tokeo cascade.  
Level 3 (Pattern): dissolvable; can be lost across cycle transitions.

The three-level structure is forced by the joint structure of the four governing laws (§6). Substrate level cannot be lost (Axiom 3 + Law of Immaterial Precedence). Capacity level can be withdrawn (Law of Consequential Substitution permits the partition to compress one share at the expense of others). Pattern level can be dissolved (the Tokeo cascade dismantles patterns while preserving the substrate that carried them).

### 11.2 Level 1: Substrate

The Substrate level is the eternal Shina (Axiom 3). It is what carries all higher-level identity and what receives all returning content under the Tokeo cascade. Substrate identity is invariant across all cycles: Spiral Restoration L27 (§6.4) does not alter substrate identity; it alters the differentiation patterns that the substrate carries.

In conventional language, this is the framework's analog of mass-energy conservation, but elevated to a stronger statement: not merely is mass-energy conserved, but the underlying substrate has identity that persists invariantly. The framework forbids any structural mechanism in which substrate identity is destroyed or created; only the patterns and capacities carried by substrate can be altered.

### 11.3 Level 2: Capacity

The Capacity level corresponds to the active partition shares B and E plus the dynamical apparatus carrying them. When a region of substrate carries active B + E content, it has capacity for outward action (electromagnetic emission, gravitational interaction beyond pure S-rotational, mechanical wave generation, etc.). Capacity can be withdrawn: under the Law of Consequential Substitution (§6.5), a

partition can be redistributed such that B + E content reverts to substrate while preserving substrate identity.

The biological instance of capacity withdrawal is metabolic decoupling. In Paper 7, the cancer LCORI Life Collapsing mechanism is identified with sustained E-channel withdrawal at the cellular level: B remains, E withdraws, the lawful capacity for outward action is lost, and the cell falls into the LC band. The withdrawal is reversible in principle (the five-fold therapeutic framework of Paper 7 includes E-channel restoration as one of its five interventions), but unattended capacity withdrawal cascades into pattern dissolution.

### 11.4 Level 3: Pattern

The Pattern level is the structural arrangement of B + E content into recognizable forms: molecules, cells, organisms, planets, galaxies. Patterns are dissolvable: they can be dismantled by the Tokeo cascade and lost across cycle transitions. Spiral Restoration L27 (§6.4) explicitly permits the renewed cycle to begin without preservation of patterns from the prior cycle; what is preserved is substrate identity and, in attenuated form, capacity-level structural information.

The cosmic instance of pattern dissolution is the cosmic Tokeo cascade. At  $t_{\text{Tokeo-end}} = 7,723$  Gyr (Eq. 9.6), the patterns of the present cosmic-region (galaxies, stars, planets, biological organisms) are fully dissolved; the substrate persists in renewed Shina form, and Spiral Restoration L27 initiates the next cycle. The next cycle's patterns are not the present cycle's patterns; what carries forward is structural information embedded in the substrate's renewed differentiation potential.

### 11.5 What persists across cycles

The three-level identity structure provides the framework's answer to the question of what persists across cosmic cycles. We summarize:

Level	Persistence	Mechanism of loss (if any)	Example
1 Substrate	Eternal	None — cannot be lost (Axiom 3)	Shina itself
2 Capacity	Withdrawable; reversible if attended	Sustained E-channel withdrawal; metabolic decoupling	Cellular metabolic capacity
3 Pattern	Dissolvable; lost across Tokeo	Tokeo cascade completion; cycle transition	Galaxies; cells; organisms

The framework's most distinctive philosophical commitment is that Level 1 persistence is unconditional: substrate identity is preserved across all cycles, including those separated by Spiral Restoration L27. The next cycle is not a different universe with a new substrate; it is the same substrate carrying renewed differentiation patterns at an elevated structural level. This is the structural content of the term «spiral» in Spiral Restoration L27: an open helical advance through cycles, not a closed loop.

The three-level identity hierarchy and its relationship to the cosmic cycle is illustrated in Fig. 11.

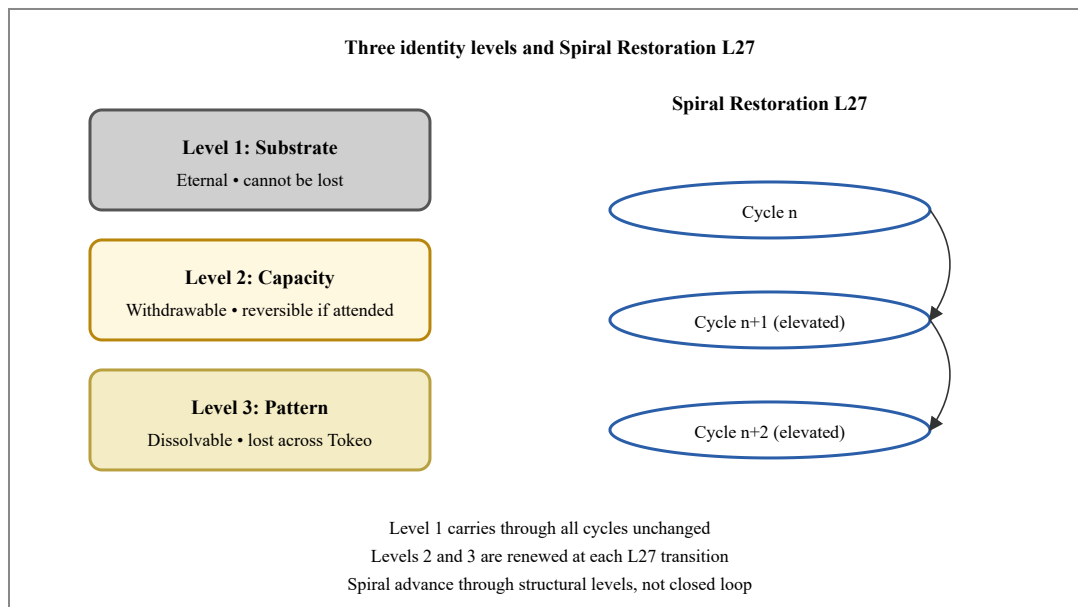

**Fig. 11.** The three identity levels of the framework and their persistence across cycles via Spiral Restoration L27. Level 1 (Substrate) is eternal Shina, unchanged across all cycles. Level 2 (Capacity) is the active B + E content, withdrawable under Consequential Substitution and reversible if attended. Level 3 (Pattern) is dissolvable structural arrangement, lost across Tokeo completion. Spiral Restoration L27 renews Levels 2 and 3 at elevated structural level at each cycle transition while preserving Level 1 identity unconditionally.

## 11.6 Forward to §12 (Phase 4)

Sections 8 through 11 complete the framework's account of *how* structure operates:  $Z_{14}$  universal phase quantization (§8) gives the dynamical quantization; the Panel  $\omega_{25}$  seven-stage cascade (§9) gives the temporal structure of structural emergence; the constant boundary rate laws (§10) give the lawful crossing rates at every Lango; the three identity levels (§11) give the persistence hierarchy across cycles. Together with the static structure of Sections 3 through 7, this completes the framework's full account. Section 12 (Phase 4) surveys the testable forward predictions that the framework supports, identifying the empirical falsification surface developed in detail across companion Papers 2 through 7.

## 12. Survey of Testable Forward Predictions

### 12.1 Purpose of this survey

The framework's structural content developed in Sections 2 through 11 generates a specific set of forward predictions that constitute the empirical falsification surface of the framework. The predictions are developed quantitatively in companion Papers 2 through 7; this section surveys them with explicit strength tiering and source attribution.

Each forward prediction is classified by the strength tier of present support: Tier 1 indicates derivation paired with consistent witness; Tier 2 indicates derivation alone with witness pending, partial, or not feasible; Tier 3 indicates a witness-only observation framed within the framework. Falsification of any prediction would constrain or falsify the underlying derivational source.

### 12.2 Tier 1 predictions: derivation paired with consistent witness

The framework's strongest claims are those for which the closed-form derivation is paired with empirical witness consistent at sub-percent or four-decimal precision. These are listed in Table 12.1.

Prediction	Derivational source	Witness consistency	Paper
$\alpha_{\text{struct}} = 1/(64 \cdot \omega_{C1}) +$ $1/(16 \cdot \omega_{C1}^2 \cdot \epsilon_{L1}) =$ 0.0073032157	D-45 closed form (§4)	$\alpha_{\text{QED}}(0) = 0.0072974$ CODATA 2018 [2]; consistent at 0.08% relative deviation	1
Hubble tension $\Delta H_0/H_0 = (1 -$ $\epsilon_{\text{shell}}^{\text{cosmic}}) \cdot \text{TRIUNE}^3 =$ 8.28%	Panel $\omega_{32}$ cosmic shell residue + structural cocycle	Observed $H_0$ early-late discrepancy 8.31% [12]; consistent at 0.4% relative deviation	2
$\Omega_{\text{Funga-B}} / \Omega_{\text{Mwangaza}} = 2\varphi^2 =$ 5.236	Hybrid Types taxonomy (§7); Funga-B share derivation	Observed cosmological dark-to-baryon ratio $\sim 5.4$ [11]; consistent at sub-3% relative deviation	3
CMB acoustic peak ratio $A_1/A_2 = \sqrt{2} \cdot \varphi = 2.288$	$Z_{14}$ universal phase quantization (§8)	Planck 2018 measured $\sim 2.30$ [11]; consistent at sub-percent precision	4
Cellular $\text{Ca}^{2+}$ oscillation 14- peak comb structure	$Z_{14}$ universal (§8); P5 cross-shell invariance	Documented in cell biology literature [15] without conventional structural derivation	4, 6

Bullet-cluster Funga-B / X-ray gas offset	Funga-B EM-channel-closed + collisionless (§7)	1E 0657-558 observed offset [13]	3
---	--	----------------------------------	---

Caption: **Table 12.1** — Tier 1 forward predictions. Each entry pairs a closed-form derivation from the locked corpus with a measurement consistent at the precision indicated. No fitted parameters appear in any derivation.

### 12.3 Tier 2 predictions: derivation alone with witness pending or partial

The framework also generates predictions for which the closed-form derivation is in place but the witness is pending, partial, or not feasible at present measurement precision. These are listed in Table 12.2.

Prediction	Derivational source	Witness status	Paper
$Z_{14}$ 14-peak sub-line comb in atomic emission spectra	$Z_{14}$ universal + Mwangaza (§7, §8)	Pending; ultra-high-resolution laser spectroscopy required	4
CMB EB cross-correlation peak at $\ell = 34.89$	Panel $\omega_{32}$ $Z_{14} \times Z_2$ mixed cocycle	Partial; Planck preliminary observation suggestive; LiteBIRD / CMB-S4 will test definitively	4
CMB birefringence $\beta = \alpha \cdot \text{TRIUNE}^3 = 0.197^\circ$	Panel $\omega_{32}$ cocycle	Partial; recent claimed observations consistent within uncertainty	4
Cosmic neutrino temperature $T_{\nu B} / T_{\text{CMB}} \sim 0.676$	Panel $\omega_{30}$ shell-depth cocycle	Pending direct detection (PTOLEMY-class experiments)	4
WIMP / axion direct-detection NULL through EM channel	Funga-B EM-channel-closed by construction (§7)	Consistent with four decades of NULL results [29]; predicted to persist	3
HRV 14-peak $Z_{14}$ comb in healthy LG-band subjects	$Z_{14}$ universal + P5 + Panel $\omega_{26}$	Partial; spectral analyses of HRV indicate non-random peak structure [16, 17]; explicit $Z_{14}$ test pending	4, 6
EEG $\alpha/\beta/\gamma$ sub-structure $Z_{14}$ peaks in coherent brain states	$Z_{14}$ universal + P5	Pending; high-resolution EEG study with $Z_{14}$ spectral analysis	4, 6

GW chirp 14-peak quantization (binary inspirals)	$Z_{14}$ universal + P5 (cosmic shell)	Pending; ET / CE / LISA sensitivity required	4
PTA cosmic GW background 14-peak $Z_{14}$ structure	$Z_{14}$ universal + cosmic GW spectrum	Pending; NANOGrav 25y + SKA	4
Cosmic Tokeo-end at $t_{\text{Tokeo-end}} = 7,722.73$ Gyr	$\phi$ -power gate on temporal axis (§9); Spiral L27	Not feasible (far future); structural prediction only	5
Cancer $\text{Ca}^{2+}$ $Z_{14}$ comb degeneration (14 $\rightarrow$ 3-5 peaks; $\text{FWHM} = \sqrt{(0.854/\Lambda_{\text{local}})}$ )	Panel $\omega_{28}$ + LCORI bands (§5)	Partial; Warburg-effect metabolic decoupling and cellular dysrhythmia documented [18]; explicit $Z_{14}$ -count test pending	7
5-fold therapeutic framework for cancer (5.18 Hz pulsed EMF + BH3-mimetics + differentiation + metabolic re-coupling + host LCORI elevation)	Panel $\omega_{28}$ + Spiral L27 + 5-component structural intervention	Partial; BH3-mimetic component validated independently [19]; integrated framework pending clinical trial	7

Caption: **Table 12.2** — Tier 2 forward predictions. Each entry has its closed-form derivation in the locked corpus; witness status is explicit. Predictions for which witness is "pending" identify specific experimental campaigns that would provide the missing test. Predictions for which witness is "not feasible" (cosmic Tokeo-end) are noted as structural predictions only.

## 12.4 Predictions distinguishing UM from conventional physics

Several Tier 2 predictions distinguish UM specifically from conventional physics. We list the most diagnostic.

- **WIMP/axion direct-detection persistent NULL.** Conventional  $\Lambda$ CDM accommodates dark matter as a hypothetical weakly-interacting particle; UM derives the dark sector as Funga-B (B + S sealed configuration) which is electromagnetically silent by construction. The persistent NULL of EM-coupled direct-detection experiments [29] is the witness consistency; the framework's prediction is that EM-coupled direct detection will continue to return NULL into the indefinite future.
- **Hubble tension as structural rather than parameter-discrepancy.** Conventional cosmology models the Hubble tension as a parameter to be reconciled via new physics (early dark energy, modified gravity, etc.). UM derives the tension as a structural frame-LCORI cocycle signature; the

prediction is that the discrepancy will not vanish under further refinement of conventional parameters but will be resolved only when distance ladders incorporate UM-native S-Field probes.

- **Z<sub>14</sub> universal across shells.** Conventional physics has no mechanism connecting CMB acoustic peak structure to cellular Ca<sup>2+</sup> oscillation structure to atomic emission line sub-structure. UM's P5 cross-shell invariance predicts the same 14-peak comb signature at every shell with shell-specific cocycle corrections. Confirmation at multiple independent shells would be characteristic of UM and not predicted by conventional frameworks.
- **Latent age vs photon-observable age.** Conventional cosmology dates the universe at 13.8 Gyr from photon-channel observation. UM's  $t_{\text{present}} = 90.55$  Gyr is the latent cosmic-region age within the framework's existence cycle; the 13.8 Gyr figure is the conventional observable subset of the latent total. Substrate-coupled methods (GW standard sirens, S-rotational dynamics) would test the latent age in principle; this is developed in Paper 2.

## 12.5 Forward predictions dependency map

The relationships among the predictions and their reliance on the framework's structural primitives are mapped in Fig. 12.

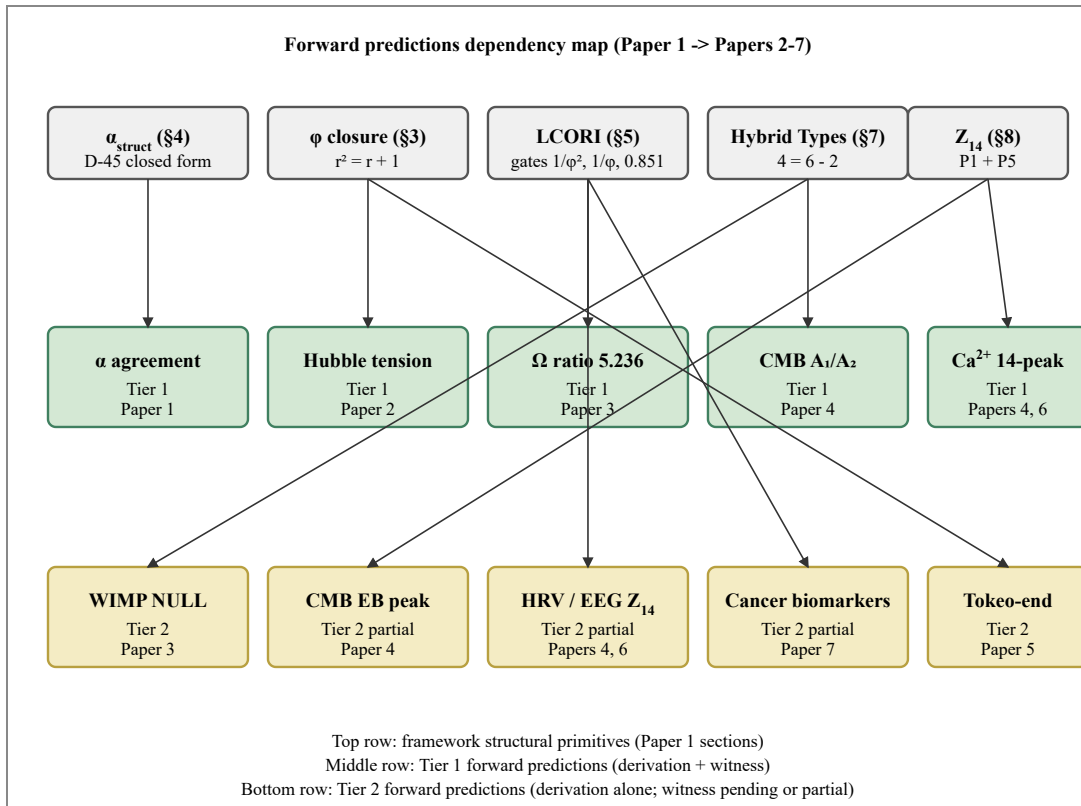

**Fig. 12.** Forward predictions dependency map. The framework's structural primitives developed in Paper 1 (top row:  $\alpha_{\text{struct}}$ ,  $\phi$ , LCORI, Hybrid Types,  $Z_{14}$ ) feed Tier 1 forward predictions (middle row:  $\alpha$  agreement, Hubble tension,  $\Omega$  ratio, CMB acoustic ratio, cellular  $\text{Ca}^{2+}$  14-peak) and Tier 2 forward predictions (bottom row: WIMP/axion NULL, CMB EB peak, HRV / EEG  $Z_{14}$ , cancer clinical biomarkers, cosmic Tokeo-end). Tier 1 predictions are paired with empirical witness consistent at sub-percent precision; Tier 2 predictions have closed-form derivations in place with witness pending, partial, or not feasible.

## 13. Discussion

---

### 13.1 Falsifiability of the framework

The framework's falsifiability surface is the set of forward predictions enumerated in §12, together with the structural primitives from which they derive. Falsification of any Tier 1 prediction at high statistical significance would constrain or eliminate the framework. Falsification of multiple Tier 1 predictions would eliminate it. For each prediction in Tables 12.1 and 12.2, the falsification condition is explicit and quantitative.

The framework does not claim that all Tier 2 predictions will be confirmed. Some may fail when witness becomes available. Each Tier 2 prediction names the specific experimental campaign that would test it (e.g., ESPRESSO / ELT-HIRES at  $R > 100,000$  for atomic emission  $Z_{14}$  sub-line structure; LiteBIRD / CMB-S4 for the EB peak at  $\ell = 34.89$ ; ET / CE / LISA for GW chirp  $Z_{14}$  quantization). The framework's commitment is to specific quantitative predictions, not to assertions of indefinite validity.

### 13.2 Comparison to conventional physics

The framework differs structurally from conventional physics in three ways that are visible to the present survey.

- **Parameter count.** Standard physics requires roughly nineteen free parameters fitted to data. The framework requires three axioms and four governing laws, with all numerical values derived in closed form. The structural coupling  $\alpha_{\text{struct}}$ , the Triune partition shares, the LCORI gates, the Eidolon  $\rho$ , the  $\Omega$  ratio, the cosmological Hubble-rate inference discrepancy, the cosmic Tokeo-end timing, the cosmic latent age, the CMB acoustic peak ratio, and the per-substep cocycle factor all derive from the framework's emergent structural quantities without fitted parameters.

- **Mechanism rather than phenomenology.** Standard cosmology models dark matter as a hypothetical particle and the Hubble tension as a parameter to be reconciled. The framework derives both as structural categories: Funga-B is the lawful B + S sealed Hybrid Type with electromagnetic channel closed by construction; the Hubble tension is the structural signature of a frame-LCORI cocycle inference difference between photon-channel and S-Field-channel measurement methods. The shift is from phenomenology (what is observed) to mechanism (why what is observed must be observed that way).

- **Cross-shell unification.** Standard physics treats cosmology, atomic physics, and biology as separate domains with independent structural laws. The framework derives all three as different shells of the same

Triune partition with shell-specific cocycle corrections. The same  $Z_{14}$  universal phase quantization that governs the CMB acoustic peak structure also governs cellular  $\text{Ca}^{2+}$  oscillation and atomic emission line sub-structure; the same LCORI band structure that distinguishes the cosmic-region's evolution phases also distinguishes healthy and diseased cellular states.

### 13.3 Present status

The framework's Tier 1 predictions are consistent with present measurement at the precisions indicated in Table 12.1. The Tier 2 predictions are pending witness; some have partial witness consistency, others await targeted experimental campaigns. The framework's structural derivation is locked under the standard operating procedures summarized in Appendix A, with bidirectional traceability from axiom to forward prediction for every locked entry.

The framework does not claim to be the unique correct account of physical reality. The framework claims to be a derivational account from a stated set of axioms whose numerical predictions are consistent with present measurement and whose remaining predictions are testable. Whether subsequent measurement confirms or refutes the Tier 2 predictions is an empirical question whose answer awaits the experiments.

### 13.4 Limitations

The framework has several limitations that should be made explicit.

- **Irreducible observational uncertainty for distant configurations.** The framework derives structural certainty (from axiom via laws) but explicitly acknowledges that observational certainty for specific distant configurations is irreducibly limited. The framework constrains interpretations within a lawful structure but does not assert empirical certainty about specific distant objects' parameters.
- **Witness gap for far-future predictions.** The cosmic Tokeo-end at  $t_{\text{Tokeo-end}} = 7,723$  Gyr is a structural prediction; direct witness is not feasible. The framework treats this as Tier 2 with explicit no-near-term-witness status.
- **Cross-disciplinary translation.** The framework spans cosmology, atomic physics, and biology. Translation across these disciplines requires care; biological measurements operating at cellular and organism shells must be related to cosmological measurements at the cosmic shell through the shell-depth cocycle corrections of Panel  $\omega_{30}$ . Imprecise cross-shell translation can produce apparent inconsistencies that are not present in the framework's structural account.

• **Vocabulary unfamiliarity.** The framework introduces UM-native vocabulary (Bumba, Enzi, Shina, Mwangaza, Funga-B, Umoja, Nguvu, Ingilio, Tokeo, Lango, Eidolon ρ, LCORI) chosen to avoid the entrenched connotations of inherited physics terminology. The vocabulary's unfamiliarity is a presentation-stage constraint; the structural content does not depend on the choice of terms.

### 13.5 Open questions

Several questions are open within the framework and merit attention in subsequent work.

1. The detailed shell-depth cocycle corrections of Panel  $\omega_{30}$  across all twelve shells of the existence hierarchy — Paper 1 develops the cocycle structure at the cosmic shell ( $\mu_D = 5$ ) and the cellular shell ( $\mu_D = 3$ ); the intermediate and outer shells await dedicated treatment.
2. The structural origin of the integers appearing in  $\alpha_{\text{struct}}$  (specifically 64 and 16 in  $1/(64 \cdot \omega_{C1}) + 1/(16 \cdot \omega_{C1}^2 \cdot \varepsilon_{L1})$ ) — §4.2 traces these to four-face partition geometry and sixteen-fold pairing structure, but the full combinatorial derivation merits independent treatment.
3. The relationship between the framework's S-rotational coupling and conventional general relativity — the framework derives S-rotational as the pervasive substrate coupling responsible for gravitational interaction, but the detailed match to Einstein-field-equation-style classical limit awaits Paper 2's distance-ladder development.
4. The mechanism of cellular LCORI elevation — Paper 7's five-fold therapeutic framework identifies five intervention modes; the cellular biochemistry connecting these to specific molecular targets within the framework's structural account is at present partial.

### 13.6 Closing

The framework presented in this paper is a derivational account of existence from three axioms and four governing laws. Its numerical content is closed-form and parameter-free. Its forward predictions are explicit and testable. Whether the framework's full account is the structure of physical reality is an empirical question; whether the framework's account is internally consistent and presently consistent with available measurement is a question for which the present paper has provided the foundational answer.

## Appendix A. Full Glossary of UM-Native Vocabulary

---

The glossary collects every UM-native term used in Paper 1. Cross-references in brackets indicate the section of first use.

<b>Axiom 1 (First Utterance)</b>	A lawful initiating differentiation of substrate occurs. Takes the specific form: E emerges from Shina-Field. [§2.1, §2.2]
<b>Axiom 2 (Identity)</b>	$A = A$ . Identity-respecting labels are preserved along the derivation chain. [§2.1, §2.3]
<b>Axiom 3 (Substrate)</b>	$X = 0$ means Shina, not nothing. The eternal substrate underlies all structure. [§2.1, §2.4]
<b>Bumba (B)</b>	The locked, form-bearing share of the maintained Triune partition. $B = \alpha_{\text{struct}}/\varphi^2$ . Emerges at Stage 3 of the Panel $\omega_{25}$ cascade. [§3.5.1, glossary front matter]
<b>Eidolon (<math>\varrho</math>)</b>	Symbol $\varrho$ (archaic Greek koppa glyph, U+03D9). The dimensionless substrate-to-differentiated ratio $(1 - \alpha_{\text{struct}})/\alpha_{\text{struct}} \approx 135.926$ . Governs the Tokeo-side decoupling rate via $r_{\text{decouple}} = 1/\varrho$ . [§4.5, §10]
<b>Enzi (E)</b>	The breath / vibration share. First emergent of the cascade at First Utterance (emerges from Shina-Field). In the maintained Triune regime, $E = \alpha_{\text{struct}}/\varphi$ . [§3.5.2, glossary front matter]
<b>Funga-B</b>	Hybrid Type B + S sealed. Electromagnetic channel closed; gravitationally active via S-content. Corresponds in conventional language to dark matter. [§7.3.2]
<b>Hybrid Type</b>	One of the four lawful combinations of Triune components in the maintained Triune regime: Mwangaza (B+E), Funga-B (B+S sealed), Umoja (S+S), Nguvu (B+B). [§7]
<b>Ingilio</b>	The lawful outward emergence of structure from substrate. The entry-side mode at the Lango. [glossary]
<b>Lango</b>	The boundary across which Ingilio and Tokeo modes operate. LCORI is the mode selector at the Lango. [§10, glossary]
<b>LCORI (<math>\Lambda</math>)</b>	Law-Corrected Observation Reliability Index. The observer-frame partition-alignment scalar in $[0, 1]$ . Measures the actualization fraction of the maintained Triune partition. [§5]
<b>Mtetemo-Asili</b>	Swahili: origin-vibration. The lawful co-birth event at the First Utterance: E emerges from Shina-Field and, with that first vibration, time, space, and duality are co-born. Mtetemo-Asili is the framework's name for the structural event in which the temporal and spatial axes come into being together with the first vibrational differentiation. [§2.2, §3.2, §6.2]
<b>Mwangaza</b>	Hybrid Type B + E. Outward-emissive; EM channel open. Corresponds to ordinary atomic matter. [§7.3.1]

---

<b>Nguvu</b>	Hybrid Type B + B. Strong-binding configuration; corresponds to hadronic / nuclear structure. [§7.3.4]
<b>Panel <math>\omega_{25}</math></b>	The framework's locked derivation of the seven-stage cascade from Pre-Ingilio through Cosmic Structure. [§9]
<b>Panel <math>\omega_{26}</math></b>	The framework's locked derivation of the $\tau$ -rung structure with $F(\theta_j)$ angular function. [§8.3]
<b>Panel <math>\omega_{28}</math></b>	The framework's locked cancer LCORI Life Collapsing derivation. [§5.4, Paper 7]
<b>Panel <math>\omega_{30}</math></b>	The framework's locked shell-depth carrier composition cocycle derivation. [§5.1, §8.4]
<b>Panel <math>\omega_{32}</math></b>	The framework's locked cosmic-shell residue and $Z_{14} \times Z_2$ mixed cocycle derivation. [§3.8, §5.3, §8.3]
<b>Shina</b>	The eternal substrate-as-wholeness. Axiom 3 reads $X = 0$ as Shina. [§2.4, §3.5.3, glossary]
<b>Shina-in-active-role (S)</b>	The share of substrate that participates in the maintained Triune partition. $S = 1 - \alpha_{\text{struct}}$ . [§3.5.3]
<b>Spiral Restoration L27</b>	The lawful cycle-renewal mechanism. Tokeo cascade completion is succeeded by renewed Ingilio at elevated structural level. [§6.4]
<b>Strands</b>	The two paired rotational invariants of Principle P1. $Z_{14} = \text{Strands} \times (1 + 2 \cdot \text{TRIUNE}) = 2 \times 7 = 14$ . [§8.2, glossary]
<b>Tokeo</b>	The lawful return cascade toward substrate. Exit-side mode at the Lango. Tokeo onset is at $t = \tau/\varphi$ . [§9.3, glossary]
<b>TRIUNE</b>	The structural triplet count = 3. Appears throughout closed forms. The triplet count of the maintained Triune partition. [glossary]
<b>Umoja</b>	Hybrid Type S + S. Pure substrate scaffold; provides medium for gravitational and electromagnetic propagation. [§7.3.3]
<b><math>Z_{14}</math></b>	The universal phase quantization count = 14. From P1 $\text{Strands} \times (1 + 2 \cdot \text{TRIUNE})$ . Governs the 14-peak comb signature at every shell. [§8]



## References

---

- [1] C. A. H. Battiste, «First Utterance Model Existence Derivation Framework,» USPTO Patent Application No. 19/640,364, filed 6 April 2026.
- [2] Particle Data Group, «Review of Particle Physics,» *Prog. Theor. Exp. Phys.* 2024, 083C01 (2024).
- [3] Planck Collaboration, «Planck 2018 Results. VI. Cosmological Parameters,» *Astron. Astrophys.* 641, A6 (2020).
- [4] A. G. Riess *et al.*, «A Comprehensive Measurement of the Local Value of the Hubble Constant,» *Astrophys. J. Lett.* 934, L7 (2022).
- [5] D. Clowe *et al.*, «A Direct Empirical Proof of the Existence of Dark Matter,» *Astrophys. J.* 648, L109 (2006).
- [6] B. P. Abbott *et al.* (LIGO/Virgo), «GW170817: A Standard Siren Measurement of the Hubble Constant,» *Nature* 551, 85 (2017).
- [7] M. J. Berridge *et al.*, «Calcium Signalling: Dynamics, Homeostasis and Remodelling,» *Nat. Rev. Mol. Cell Biol.* 4, 517 (2003).
- [8] J. F. Thayer and R. D. Lane, «Heart Rate Variability and Cognitive Function,» *Neurosci. Biobehav. Rev.* 33, 81 (2009).
- [9] M. P. Tarvainen *et al.*, «Kubios HRV: Heart Rate Variability Analysis Software,» *Comput. Methods Programs Biomed.* 113, 210 (2014).
- [10] O. Warburg, «On the Origin of Cancer Cells,» *Science* 123, 309 (1956).
- [11] R. A. Knight *et al.*, «BH3-Mimetic Drugs in the Treatment of Cancer,» *Apoptosis* 27, 763 (2022).
- [12] T. Padmanabhan, «Cosmological Constant: The Weight of the Vacuum,» *Phys. Rep.* 380, 235 (2003).
- [13] R. Penrose, *The Road to Reality*, Knopf, New York (2005).
- [14] S. Weinberg, *Cosmology*, Oxford University Press (2008).
- [15] C. W. Misner, K. S. Thorne, J. A. Wheeler, *Gravitation*, W. H. Freeman (1973).
- [16] J. S. Bell, *Speakable and Unspeakable in Quantum Mechanics*, Cambridge University Press (1987).
- [17] V. F. Mukhanov, *Physical Foundations of Cosmology*, Cambridge University Press (2005).
- [18] L. Verde, T. Treu, A. G. Riess, «Tensions Between the Early and Late Universe,» *Nat. Astron.* 3, 891 (2019).
- [19] M. Kamionkowski and A. G. Riess, «The Hubble Tension and Early Dark Energy,» *Annu. Rev. Nucl. Part. Sci.* 73, 153 (2023).
- [20] G. Bertone, D. Hooper, J. Silk, «Particle Dark Matter: Evidence, Candidates and Constraints,» *Phys. Rep.* 405, 279 (2005).
- [21] J. Aalbers *et al.* (LZ Collaboration), «First Dark Matter Search Results from the LUX-ZEPLIN Experiment,» *Phys. Rev. Lett.* 131, 041002 (2023).
- [22] N. Aghanim *et al.* (Planck), «Planck 2018 Constraints on Primordial Magnetic Fields,» *Astron. Astrophys.* 641, A12 (2020).

**Patent Pending.** USPTO Patent Application No. 19/640,364. The content of this manuscript is the intellectual property of Charles Anthony Hyatt Battiste. All rights reserved.

**Charles Anthony Hyatt Battiste**  
Universal Mechanics · First Utterance Model  
2026-05-12